

Magnetic door release – GTR048000A07

Product Datasheet

Features

- Clearly visible red release pushbutton
- Spring ejector
- Retaining force 400N (40 kg)
- Tested according to EN 1155
- Designed to meet EN 54 requirements and conforms to CE standards

Application/Description

The magnetic door release GTR048000A07 is used to keep open the fire barrier or passage doors and release them in the event of fire. The unit is made of two parts, the electromagnetic nucleus and the keeper plate. It is provided with a red pushbutton for manual release. Integrated reverse polarity protection diode and spark suppressing diode.

Mounting

The electromagnet is to be mounted on the wall, and the connection on the door.



Technical specifications	
Weight	630 g (magnet and keeper plate)
Colour	Grey (RAL 7035)
Dimensions	See illustration
Nominal voltage	24 VDC
Nominal current	67 mA
Power supply	22-28 VDC
Circuit configuration	Solenoid diode polarised & suppressed
Holding force	40 kg / 400 N
Connections	Screw terminals
Housing	Bayblend and PA6 glass fibre
Degree of protection	Magnet: IP54 Connection: IP42
Manual release	Yes
Temperature	-5° to +35°C

Part number	Description
116-6731-017.0007	Magnetic door release w/keeper plate

Connection

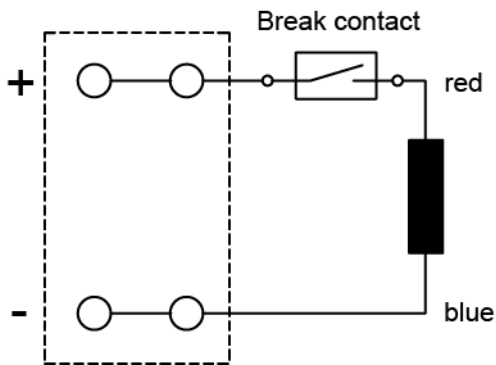

Dimensions (mm)

