

DUAL MONITORED INPUT/OUTPUT UNIT – BN-305

Interactive fire detection systems Product Datasheet

Features

- Interactive
- For interfacing and controlling external units to Autronica's interactive fire detection systems
- Multi function unit: Function selected by switch setting.
- Input/Output signals
- 2 non-isolated inputs: on /off function with end-of-line monitoring
- 2 outputs: Potential free contact without end-of-line monitoring
- 1A 30 VDC dry relay contact for the output ports
- Includes the SelfVerify function for reduced maintenance/testing and increased reliability on the input for critical alarm functions
- Short-circuit isolator in each unit
- Automatic addressing
- Proven technology
- Wall mounted
- Designed to meet the requirement of the major maritime classification societies
- Approved according to EN-54-17, EN 54-18

Description

The Dual Monitored Input/Output Unit BN-305 has been designed for use with Autronica's interactive fire detection systems, AutoPrime and AutoSafe, and includes the SelfVerify function. This function ensures the highest grade of reliability and reduces the need for manual testing because the panel is able to continuously and automatically check all units that include this function.

Note: External devices attached to this interface unit require a separate power source (they cannot be powered by the detector loop).

SelfVerify: The unit's ability to initiate alarm is regularly checked.

Function options / Switch settings

The internal DIP switch S1 selects the function performed by the BN-305 unit. For location of the DIP switch, refer to circuit board drawing on the next page. Refer to detailed descriptions of each function on this datasheet (Descriptions of function options).

The available functions include:

- Function A
Alarm condition signalling input unit with relay feedback



- Function B
Pre Alarm condition signalling input unit with relay feedback
- Function C
Fault condition signalling input unit with relay Feedback
- Function D
Uncommitted input unit (Output follows input)
- Function E
Pre Alarm and Alarm condition signalling input unit with configurable input delay and relay feedback
- Function F
Fault, Pre Alarm and Alarm condition signalling input
- Function G
Alarm condition signalling input unit with relay output used for reset
- Function H
Alarm condition signalling input and independent relay output function
- Function I
Uncommitted input unit and independent relay output function
- Function J
Relay output function (Input not in use)
- Function K
Relay output function with activation feedback (input)
- Function L
Relay output function with activation feedback of both positions
- Function M
Relay output function with activation feedback and external fault input
- Function N
Pre Alarm and Alarm condition signalling input unit with relay feedback

Technical specifications	
Dimensions (mm)	125 x 125 x 75
Weight (g)	390
Housing material	Polyamide 6.6.
Colour	Light grey
Mounting	Wall mounting, 110 mm bolt space
Power	Connects to AL_Com loop only
Current consumption	0,1 mA
Temperature range	-25 to +70 °C
Humidity	10 % - 95 % RH (non-condensing)
Degree of protection	IP67
Cable glands (PG-13,5), included	
Communication loop protocol	Autronica loop communication protocol (AL_Com)
Cable terminals	Max 2.5 mm ² single core wires
Cable requirements AL_Com	Refer to specification for AutoSafe or Autoprime
Maximum input cable length	100 m
Maximum cable capacitance	30 nF
Serial impedance ZC Max	40mΩ
Response time	<= 1 second
Output relay rating	1 A 30 VDC
Output relay type	Dry contact, Latching type; keep state on loss of power. No EOL monitoring
Threshold	Short-circuit: 0-235 Ω Normal: 1200-4800 Ω Activate: 260-1000 Ω <i>Open circuit: 5400-∞ Ω</i>
LED	3 ms flash at 0,5 Hz Output: 10 mA current source 16-24 VDC Maximum length of connected wire: 3 m
Approvals	See website

 0470
Autronica Fire and Security AS, N-7483 Trondheim 11 0470-CPD-0031
EN 54-17:2005 Short circuit isolators EN 54-18:2005 Input/output devices

Part number	Description
116-BN-305	Dual monitored input/output unit

Connectors

All connections are made to screw terminals numbered 1-12.

Terminal	Function
1	AL_Com In (+)
2	AL_Com In (-)
3	AL_Com Out (+)
4	AL_Com Out (-)
5	Input 1 (+)
6	Input 1 (common)
7	Relay 1 contact
8	Relay 1 contact
9	Input 2 (+)
10	Input 2 (common)
11	Relay 2 contact
12	Relay 2 contact

LED connectors

Terminal	Function
J2.1	LED1 + (LED Activate)
J2.2	LED1 - (LED Activate)
J2.3	LED2 + (LED Fault)
J2.4	LED2 - (LED Fault)

LED connector: A pin header enables the option to add LED indicators. The indication is a short blink at 0,5Hz period.
LED activate: The input or output is in Activation condition.
LED fault: There is a fault on the input or the unit itself.

Dimensions

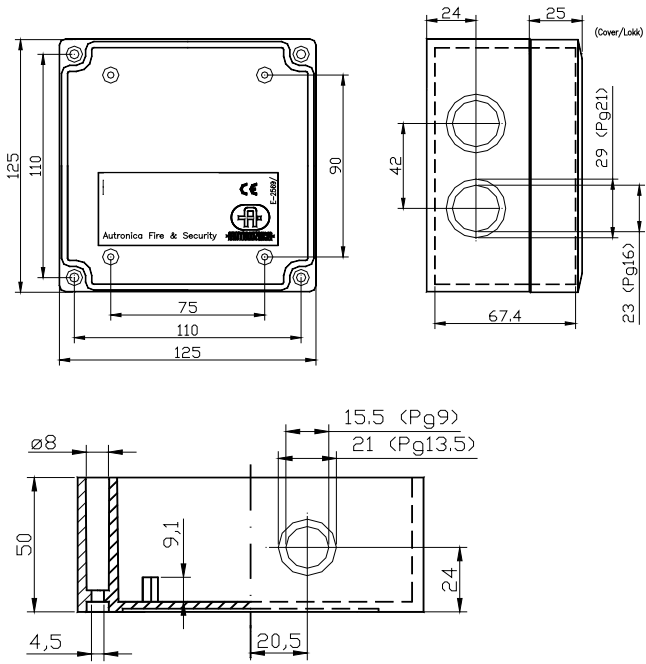

Connectors and DIP switches on circuit board

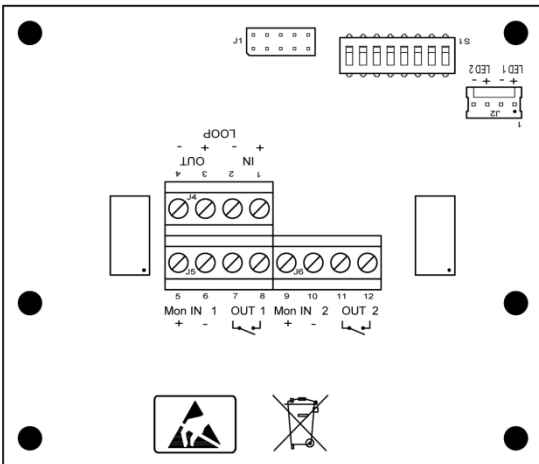

Descriptions of connection options

Input configuration A

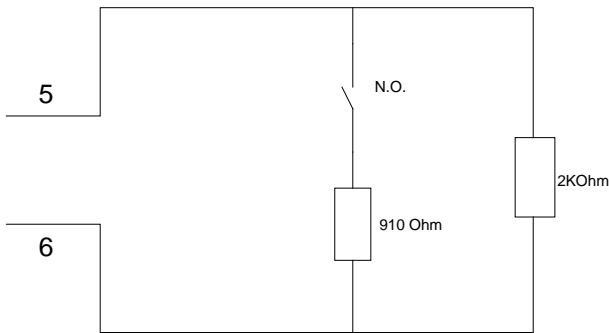

Input configuration B

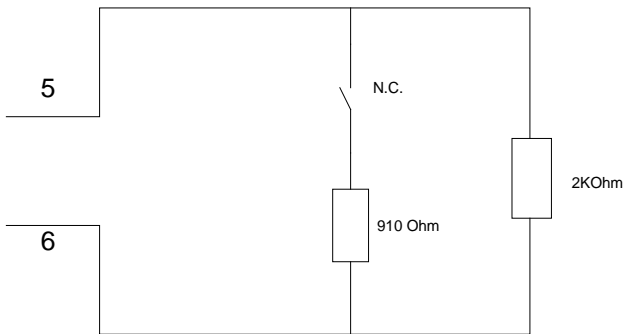

Input configuration C

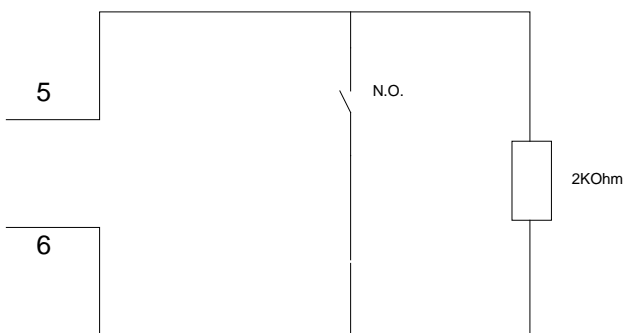

Input configuration D

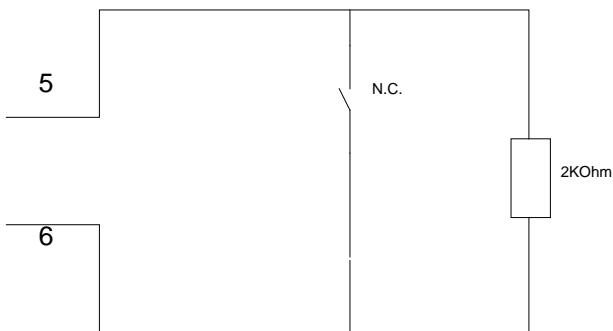
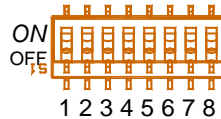

Figure 1

The electrical connection options for the input to the unit are shown in Figure 1. The various electrical input configurations allow a user to select under what condition the unit will be ‘triggered’ to provide a signal the fire alarm system indicating the selected condition.

The four different behaviours can be configured by DIP switch 5 and 6 in order to be able to monitor different setups of the input contact(s). (Switch 8 is not used).



(See location of DIP switch S1 on the circuit board drawing)

Input configuration A activates when the contacts are closed. This arrangement also allows the unit to monitor for an electrical wiring fault in the form of an open or short-circuit, between the contacts and the unit, either before or during activation.

S1.5	S1.6
OFF	OFF

Normally Open contact with ‘activate’ resistor, fault monitored for open and short-circuit.

Input configuration B activates when the contacts are opened. This arrangement allows the unit to monitor for an electrical wiring fault in the form of an open or short-circuit, between the contacts and the unit, either before or during activation.

S1.5	S1.6
OFF	ON

Normally Closed contact with ‘activate’ resistor, fault monitored for open and short-circuit.

Input configuration C activates when the contacts are closed. This arrangement allows the unit to monitor for an open circuit fault in the electrical wiring before activation. A short-circuit in the wiring will trigger the unit.

S1.5	S1.6
ON	OFF

Normally Open contact without ‘activate’ resistor, fault monitored for open circuit.

Input configuration D activates when the contacts are opened. This arrangement allows the unit to monitor for an open circuit fault in the electrical wiring during activation.

S1.5	S1.6
ON	ON

Normally Closed contact without ‘activate’ resistor, fault monitored for open circuit.

The output can be set to Normal Open or Normal Closed operation by DIP switch 1.7:

- DIP 1.7 OFF = Normally open
- DIP 1.7 ON = Normally closed

DIP switch 1.8 determines the state of output if the unit loses its power.

- DIP 1.8 OFF = Relay remains in current state
- DIP 1.8 ON = Relay switches to initial state as chosen by DIP 1.7

Descriptions of Function Options

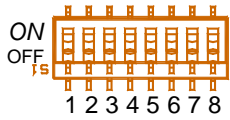

(See location of DIP switch S1 on the circuit board drawing)

Function A

S1.1	S1.2	S1.3	S1.4
OFF	OFF	OFF	OFF

Function: Alarm condition signalling input unit with feedback function.

The relay contact will follow the state of the input .

Number of addresses: 2

Application include:

- Fire Alarm push buttons
- Flame, heat or beam detectors with relay contacts
- Sprinkler contacts, etc.

Function B

S1.1	S1.2	S1.3	S1.4
ON	OFF	OFF	OFF

Function: Pre Alarm condition signalling input unit with feedback function.

The relay contact will follow the state of the input.

Number of addresses: 2

Application include:

- Manual input for Pre Alarm
- Pre Alarm input from a detector with relay output
- Sprinkler contacts, etc.

Function C

S1.1	S1.2	S1.3	S1.4
OFF	ON	OFF	OFF

Function: Fault condition signalling input unit with feedback function.

The relay contact will follow the state of the input.

Number of addresses: 2

Application includes:

- Monitoring of associated equipment for faults
- Monitoring of detectors with relay contacts

Function D

S1.1	S1.2	S1.3	S1.4
ON	ON	OFF	OFF

Function: Uncommitted input.

Number of addresses: 2

Applications:

A typical application is monitoring of the power fault contact in the power supply or a fire pump. This unit can be used for:

- Monitoring of water level detection systems
- Monitoring of smoke control damper systems
- Monitoring of extinguishing systems

Relay contact closes when input is activated.

Function E

S1.1	S1.2	S1.3	S1.4
OFF	OFF	ON	OFF

Function: Delayed Alarm condition signalling input unit with feedback function. Input delay 2 seconds. Configurable delays for entering Pre Alarm and Alarm condition. Default delays: Pre Alarm 10 seconds, Alarm 20 seconds.

The relay contact will follow the state of the input.

Number of addresses: 2

Application include:

- Sprinkler contacts, etc.

Function F

S1.1	S1.2	S1.3	S1.4
ON	OFF	ON	OFF

Function: Fault, Pre Alarm and Alarm condition.

Number of addresses: 2

Applications include:

- Fire detectors with two-level output (Pre Alarm and Alarm).

Relay contact activates for a configurable period when the unit is reset. This provides a pulse with 5 seconds interval for resetting the external detector.

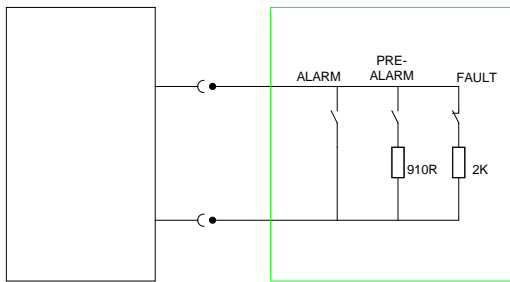

Function G

S1.1	S1.2	S1.3	S1.4
OFF	ON	ON	OFF

Function: Alarm condition signalling input unit with reset function for external detector.

Relay contact activates for a configurable period when the unit is reset. This provides a pulse with 5 seconds interval for resetting the external detector.

Number of addresses: 2

Application include:

- Flame, heat or beam detectors with relay contacts

Function H

S1.1	S1.2	S1.3	S1.4
ON	ON	ON	OFF

Function: Alarm condition signalling input and independent relay output function.

Number of addresses: 4

Input application includes:

- Fire Alarm push buttons
- Flame, heat or beam detectors with relay contacts
- Sprinkler contacts, etc.

The output unit contains a potential free contact, which can be activated from a detector or a combination of several detectors or other preconfigured cause and effect relationships. No end-of-line monitoring on output function. The output can be used for:

- Door release
- Sprinkler control/functions
- Control of fire dampers
- FPE/FAD without bell patterns

Function I

S1.1	S1.2	S1.3	S1.4
OFF	OFF	OFF	ON

Function: Uncommitted input and independent relay output function.

Number of addresses: 4

Applications:

A typical application is monitoring of the power fault contact in the power supply or a fire pump. This unit can be used for:

- Monitoring of water level detection systems
- Monitoring of smoke control damper systems
- Monitoring of extinguishing systems

The output unit contains a potential free contact, which can be activated from a detector or a combination of several detectors or other preconfigured cause and effect relationships. No end-of-line monitoring on output function. The output can be used for:

- Door release
- Sprinkler control/functions
- Control of fire dampers
- FPE/FAD without bell patterns

Function J

S1.1	S1.2	S1.3	S1.4
ON	OFF	OFF	ON

Function: Relay output function (input not in use)

Number of addresses: 2

Applications:

The output unit contains a potential free contact, which can be activated from a detector or a combination of several detectors or other preconfigured cause and effect relationships. The output can be used for:

- Door release
- Sprinkler control/functions
- Control of fire dampers
- FPE/FAD without bell patterns

Function K

S1.1	S1.2	S1.3	S1.4
OFF	ON	OFF	ON

Function: Relay output function with activation feedback monitoring. Default delay for change of position is 17 seconds. At activation there is a 30 seconds delay before a technical alarm is initiated. When the door closes an indication of this status is given. When the door is closed, an indication of this status is sent after 120 seconds. All delays are configurable.

Number of addresses: 2

Applications:

- Door control and monitoring
- Fire damper control and monitoring
- Low location lights control and monitoring
- Other equipment

Function L

S1.1	S1.2	S1.3	S1.4
ON	ON	OFF	ON

Function: Relay output function with activation feedback monitoring (output 2 not in use).

Both inputs are used to achieve monitoring of both end positions

Number of addresses: 1

Applications:

- Door control and monitoring
- Fire damper control and monitoring

- Other equipment

Function M

S1.1	S1.2	S1.3	S1.4
OFF	OFF	ON	ON

Function: Relay output function with activation feedback monitoring (output 2 not in use).

The second input is used for external fault input.

Number of addresses: 1

Applications:

- Door control and monitoring
- Fire damper control and monitoring
- Low location lights control and monitoring
- Other equipment

Function N

S1.1	S1.2	S1.3	S1.4
ON	OFF	ON	ON

Function: Pre Alarm and Alarm condition signalling input unit with feedback function.

One input is used for Pre Alarm and the other for Alarm. Relay contacts closes when the pre alarm state or alarm state is entered, and opens when the unit is reset. (Output 2 not in use).

Number of addresses: 1

Application include:

- Pre Alarm and Alarm input from a detector with relay outputs