

# TVE-110/410/810/1610 H.264 IP Video Encoder User Manual

**Copyright** © 2015 United Technologies Corporation.

Interlogix is part of UTC Building & Industrial Systems, a unit of United Technologies Corporation. All rights reserved.

**Trademarks and patents** Trade names used in this document may be trademarks or registered trademarks of the manufacturers or vendors of the respective products.

**Manufacturer** Interlogix  
2955 Red Hill Avenue, Costa Mesa, CA 92626-5923, USA  
Authorized EU manufacturing representative:  
UTC Fire & Security B.V.  
Kelvinstraat 7, 6003 DH Weert, The Netherlands

**Certification**



**FCC compliance**

**Class B:** This equipment has been tested and found to comply with the limits for a Class B digital device, pursuant to part 15 of the FCC Rules. These limits are designed to provide reasonable protection against harmful interference in a residential installation. This equipment generates, uses, and can radiate radio frequency energy and, if not installed and used in accordance with the instructions, may cause harmful interference to radio communications.

There is no guarantee that interference will not occur in a particular installation. If this equipment does cause harmful interference to radio or television reception, which can be determined by turning the equipment off and on, the user is encouraged to try to correct the interference by one or more of the following measures:

- Reorient or relocate the receiving antenna.
- Increase the separation between the equipment and receiver.
- Connect the equipment into an outlet on a circuit different from that to which the receiver is connected.
- Consult the dealer or an experienced radio/TV technician for help.

**European Union directives**

**12004/108/EC (EMC directive):** Hereby, UTC Fire & Security Americas Corporation, Inc., declares that this device is in compliance or with the essential requirements and other relevant provisions of Directive 2004/108/EC



**2012/19/EU (WEEE directive):** Products marked with this symbol cannot be disposed of as unsorted municipal waste in the European Union. For proper recycling, return this product to your local supplier upon the purchase of equivalent new equipment, or dispose of it at designated collection points. For more information see: [www.recyclethis.info](http://www.recyclethis.info).

**Contact information**

For contact information, see [www.utcfireandsecurity.com](http://www.utcfireandsecurity.com) or [www.utcfssecurityproducts.eu](http://www.utcfssecurityproducts.eu).

# Content

## **Introduction 1**

- Package contents 1
- Key features 1
- Product description 2
- Connections 3

## **Network Settings 5**

- TruVision Device Manager 5

## **Using a web browser 9**

- Before you start 9
- Accessing the web browser 9
- Menu tree 10

## **Live view 11**

- Description of live view 11
- Capturing a snapshot 12
- PTZ control 13
- Video image settings 14

## **Configuration 15**

- Local configuration 15
- Time settings 16
- Network set up 17
- Camera set up 30
- Video streaming set up 32
- Motion detection 34
- Alarm settings 36
- Video Loss 39
- Tamper-proof alarm 39
- Exception 40
- Privacy masking 41
- RS-485 settings 42
- Scheduling record settings 43
- Holiday settings 48
- Managing user accounts 49

## **Playback 52**

## **Encoder management 54**

- Searching system logs 54
- Restoring default settings 54
- Viewing device information 55
- Restarting the device 55
- Importing/exporting parameters 55

Upgrading the system 56

**Specifications 57**

# Introduction

The TruVision TVE H.264 IP video encoder converts the analog camera signal to compressed IP video streams. These streams are transited to network video recorders (NVR) or video management systems (VMS) for remote storage, live-view and playback purpose.

This user manual provides basic information on setting up and using the TVE-110, TVE-410, TVE-810 and TVE-1610 models.

The encoder is shipped with web browser menus in seven languages: English, Simplified Chinese, French, German, Portuguese, Russian, and Spanish.

## Package contents

The TruVision TVE H.264 IP video encoder is shipped with the following items:

- TVE encoder
- Power adaptor
- Power cable
- Quick start guide
- CD (includes the user manual and TruVision Device Manager)

## Key features

The following key features are supported by TVE encoders:

- 1/4/8/16-channel H.264 encoding with dual stream output
- Multiple resolution options: 960H, 4CIF, 2CIF, CIF and QCIF
- Support audio & video compounded stream
- Device configurable remote recording on NetHDD (network storage device)
- Flexible and powerful recording mechanism when used in combination with a network storage device (NetHDD): Scheduled, event triggered, alarm triggered, cycle recording, pre and post recording
- Bi-directional audio
- PTZ control via RS-485 port and burnt-in multiple PTZ protocols
- Alarm input and output
- Support ONVIF, PSIA and CGI communication
- Discoverable via the TruVision Device Manager Tool

# Product description

Figure 1: Front panel

**1-channel:**

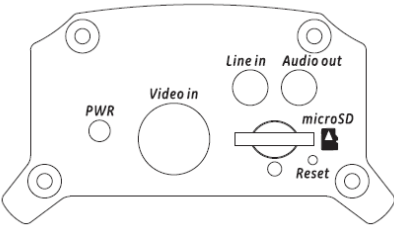

**4-channel:**

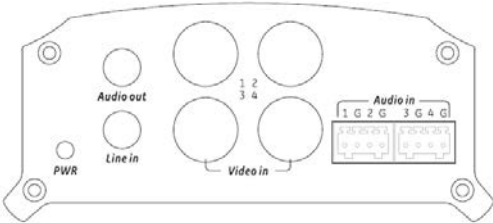

**8-channel:**



**16-channel:**



LED indicator	Description
POWER/PWR	The LED lights up RED when the device is working. It is not lit when the device is powered down.
TX/RX	The LED is not lit when there is no network connection. It lights up green and flashes when data is being transmitted/received.

Figure 2: Rear Panel

**1-channel:**

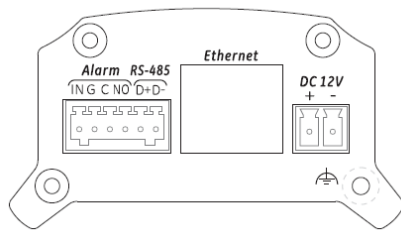

**4-channel:**

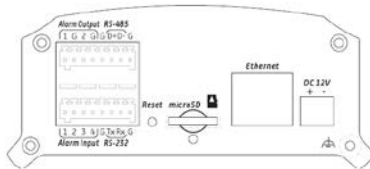

**8-channel:**

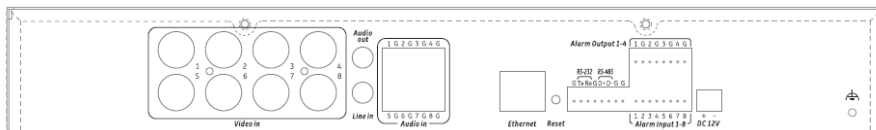

**16-channel:**

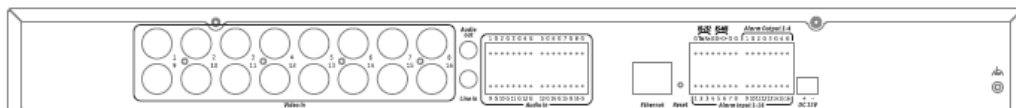

## Connections

See Figure 2 on page 3 for information on connecting the power, camera, audio and network cables.

### Alarm connections

The TVE encoder supports the open/close relay input as the alarm input mode. When the alarm input signal not in open/close relay signal mode, please follow the connections shown below:

**Figure 3: Alarm input connections**

Alarm input connections for Emerson alarm:

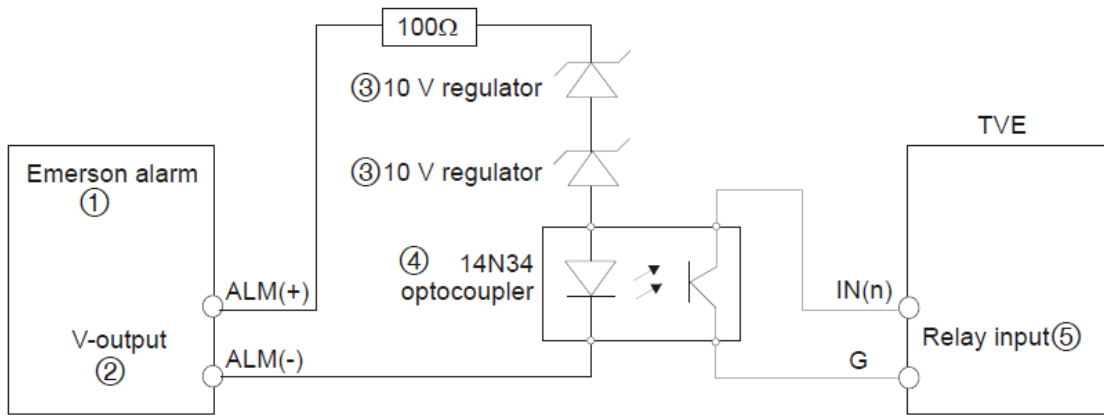

Alarm input connections for normal alarm:

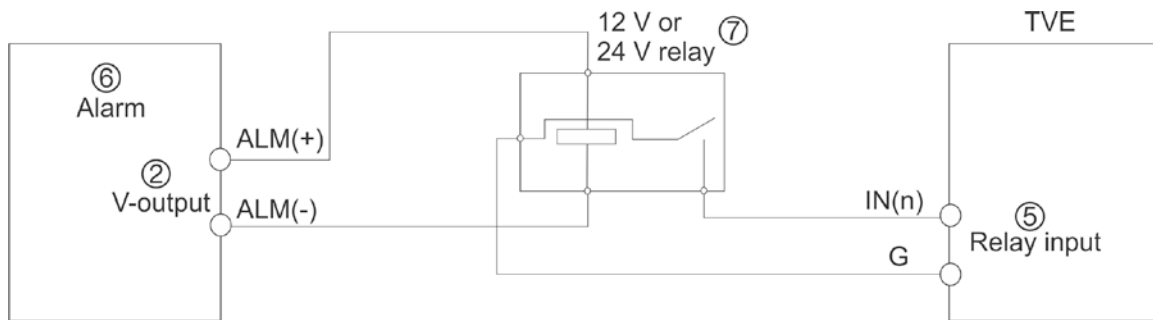

- |                   |                       |
|-------------------|-----------------------|
| 1. Emerson alarm  | 4. 4N35 optocoupler   |
| 2. V output       | 5. Relay output       |
| 3. 10 V regulator | 6. Normal alarm       |
|                   | 7. 12 V or 24 V relay |

The alarm input can be selected to NO or NC. Different alarm output connection methods are applied to the AC or DC load. See Figure 3.

For TVE-110, you need to connect G and NO manually and then connect C and NO to the alarm devices.



# Network Settings

This chapter explains how to use TruVision Device Manager to find and configure the IP address and other parameters of the device.

**Note:** The default user name of TVE is *admin*, and password is *1234*. The default IP address is 192.168.1.70

## TruVision Device Manager

The TruVision Device Manager tool can be found on the CD shipped with that product. This tool automatically identifies TruVision devices that support “auto-discovery” in the same subnets. You can view and modify the IP address of any discovered device.

### To install the TruVision Device Manager:

1. Insert the CD in the computer’s CD/DVD drive.
2. Browse to the folder Tool and double-click the Setup file located in the folder.

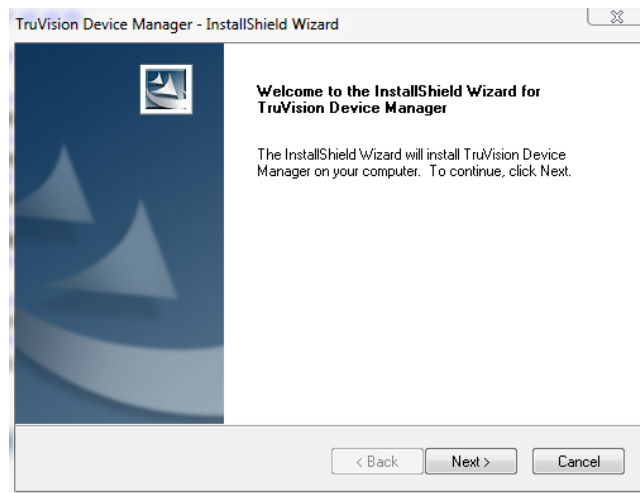

3. Click **Next**.
4. Select the folder where the setup will install the files then click **Next**.

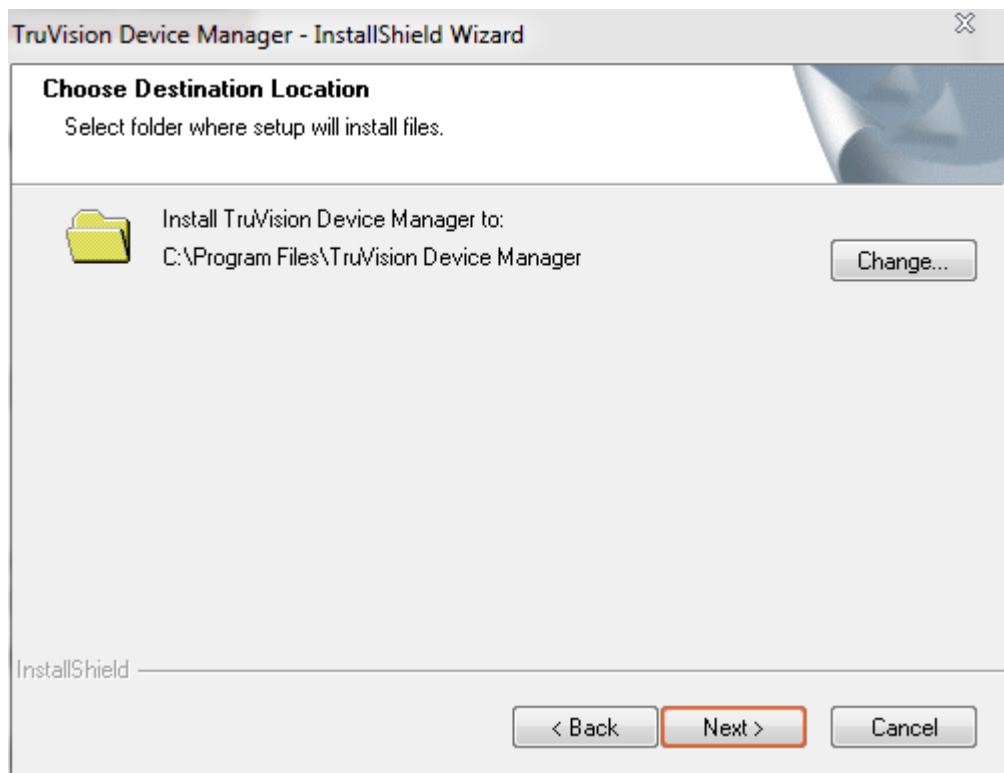

5. The program requires a utility called WinPcap to be installed on the computer. If it is already installed, go to step 6.

If the program is not installed, the WinPcap window appears. Follow the on-screen instructions.

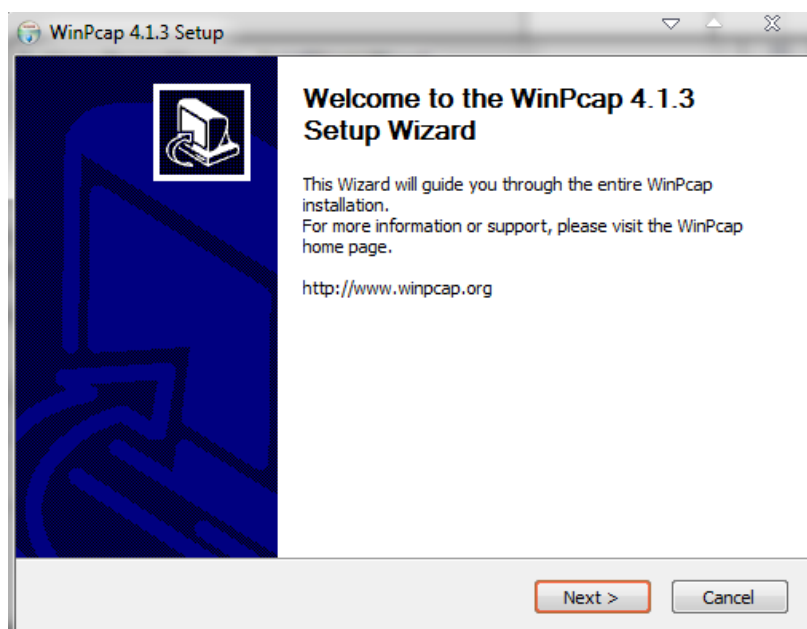

6. The TruVision Device Manager Wizard appears. Click **Finish** to complete its installation.

### Using the TruVision Device Manager

The setup will install the necessary files and place the following shortcut on your desktop.

Figure 4: TruVision Device Manager shortcut icon



### To use the TruVision Device Manager:

1. Double-click the shortcut icon to open the tool.
2. The list of TruVision devices located on your network appears.

**Note:** The TruVision Device Manager can only detect devices that are on the same LAN. The tool cannot detect devices placed on a VLAN.

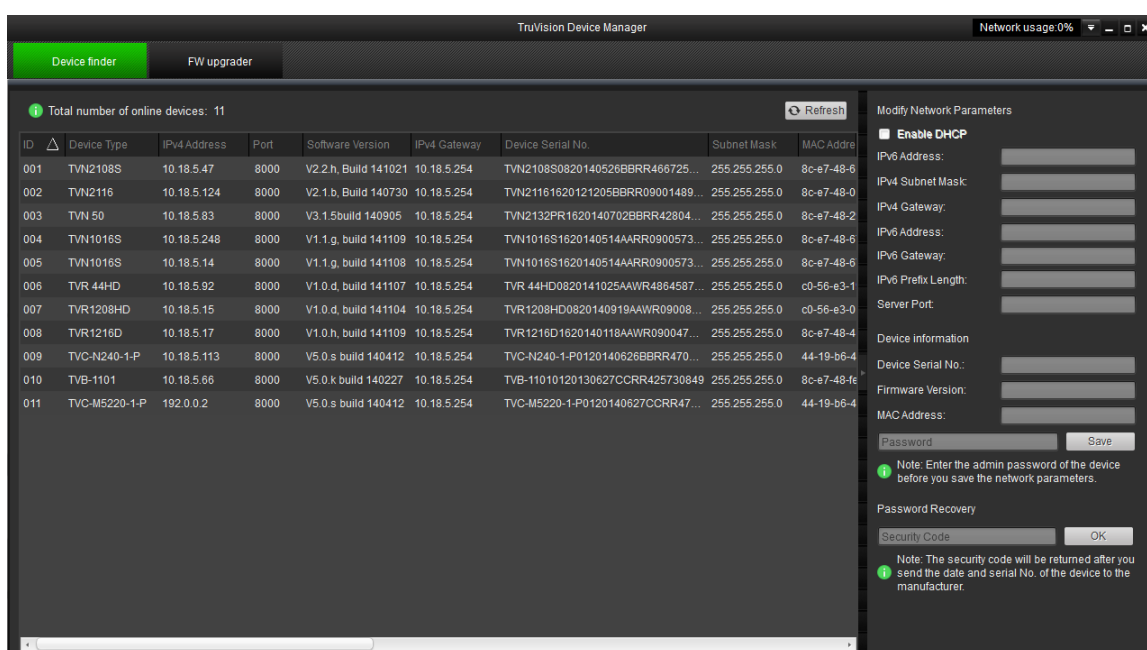

The tool identifies:

- Device type
- Device MAC address
- IP address
- Number of video channels supported by the device
- Connection port
- Software version
- Device serial number
- DSP/firmware version
- Device subnet mask
- Device start time

3. To change the IP address and/or the subnet mask of the device, click the line of the device address to be changed. The key device characteristics for that device are listed in the right pane.
4. Change/modify the IP address and or subnet mask as required. Input the device's logon password and press **Save**.
5. Repeat this process for each device that needs to be modified. When all changes to all discovered devices is complete, Click X to close the tool.

# Using a web browser

You can configure the encoder over the network with a web browser.

The supported web browsers include:

- Internet Explorer 8 and above
- Firefox 27.0.1 and above
- Chrome 33.0.1750 and above

## Before you start

- Before accessing the browser, you need to configure the network settings of encoder.
- Connect the encoder to the LAN and connect a computer to the same LAN as the encoder.
- The encoder's factory default user name is *admin* and the password is *1234*.
- The encoder's factory default IP address is 192.168.1.70.

## Accessing the web browser

**Note:** You must access the system as an administrator in order to ensure that all features of the encoder are available.

**To access the web browser:**

1. Open the web browser and enter the IP address of the encoder (for example, <http://192.168.1.70>). Press the **Enter** key on the computer.

The system displays the login window.

2. Enter the user name (default: *admin*) and password (default: *1234*) to log into the system. The main page of the encoder appears.

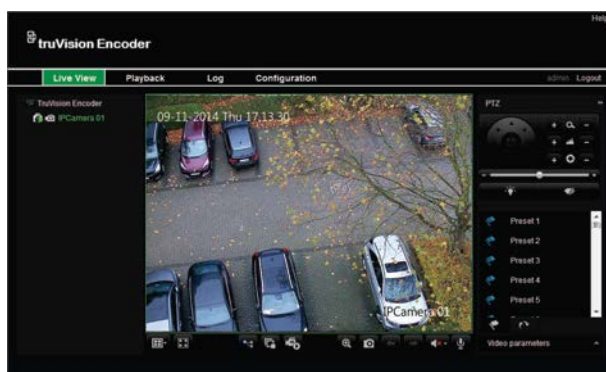

3. If you need to install the TruVision Device Manager, you can find the tool on the CD shipped with the product.

# Menu tree

Figure 5: Encoder menu tree

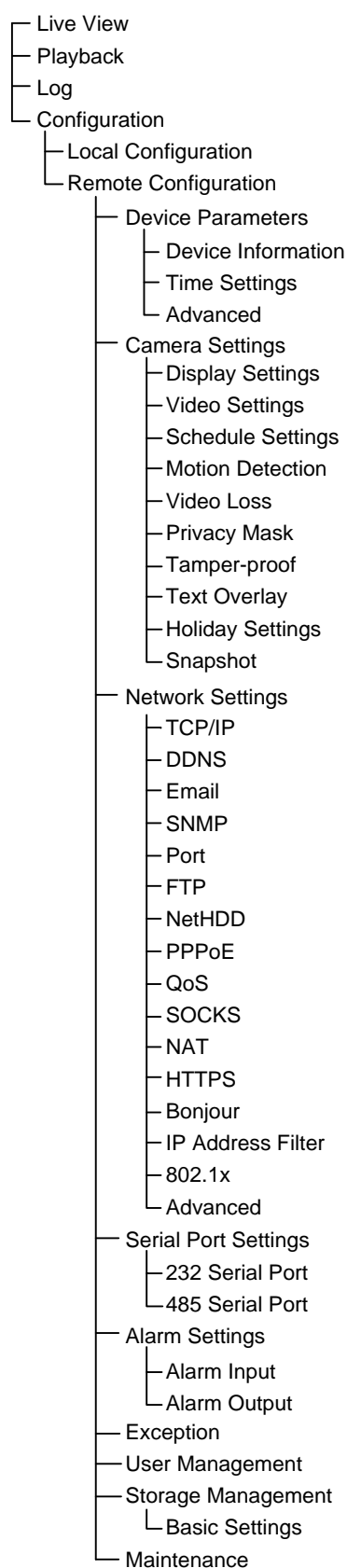



# Live view









Live view mode is the normal operating mode of the device where you watch live images from the cameras. The encoder automatically enters into live mode once powered up. On the viewer, you can see the current date and time, and camera name.

## Description of live view

Figure 6: Live view



Name	Description
1. Menu toolbar	Lets you do the following: <ul style="list-style-type: none"> <li>• View live video</li> <li>• Play back video</li> <li>• Search for event logs</li> <li>• Configure settings</li> <li>• Exit the interface</li> </ul>
2. Viewer	View live video.
3. Device list	Display the encoder and its channels.
4. Display format	<div style="display: flex; align-items: flex-start;"> <div style="margin-right: 10px;">  </div> <div> <p>Define how you want video to be displayed in the viewer; single screen, 2X2, 3X3 or 4X4.</p> <p>When in multiview mode, double-click a video tile to get full-screen mode. Double-click again to return to multiview mode.</p> </div> </div> <hr/> <div style="display: flex; align-items: flex-start;"> <div style="margin-right: 10px;">  </div> <div> <p>Click to switch to full screen mode.</p> </div> </div>

Name	Description
5. Video function toolbar	<p> Switch to main or substream.</p> <hr/> <p> Click to start/stop live view.</p> <hr/> <p> Enable e-PTZ (must be supported by the connected camera).</p> <hr/> <p> Click to capture a snapshot of a video image. The image is saved on the computer.</p> <hr/> <p> Click to manually start/stop recording video. The recording is saved on the computer.</p> <hr/> <p> Click to display the previous camera view.</p> <hr/> <p> Click to display the next camera view.</p> <hr/> <p> Click to turn audio on/off.</p> <hr/> <p> Start/Stop two-way audio.</p>
6. Video parameters	Adjust the brightness, hue, saturation and contrast of live video.
7. Preset setup/selection	Set up and select presets.
8. PTZ control panel	Control PTZ of the currently selected camera, adjust the speed of PTZ movement and turn on/off the camera light and wiper.

### To see live view:

1. Open the encoder's web browser screen. See Figure 6.
2. Double-click a camera from the device list to select a camera to view.
3. Click the **Display Format** button to view multiple video tiles.

## Capturing a snapshot

In live view mode, click the snapshot button on the video function toolbar to capture live pictures. A pop-up message will appear on screen to confirm that the capture was successful. The image is saved as a JPEG file on the computer.

**Note:** Configure where the snapshots are saved on your computer in the Configuration > Local Configuration page.



## PTZ control

You can control PTZ cameras from the encoder in live view mode.

**Figure 7: PTZ control**

Directional buttons: Control the pan and tilt movement

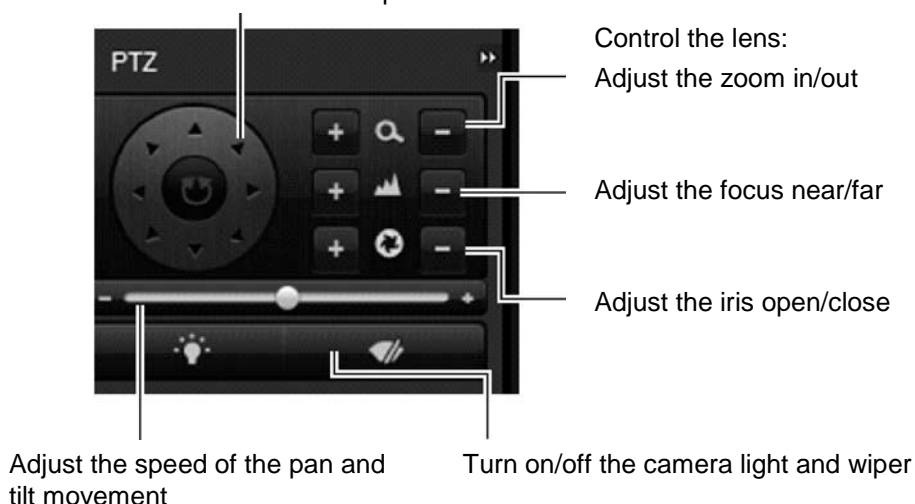

### Connecting the PTZ camera to the encoder

Ensure that the PTZ dome cameras are correctly connected to the RS-485 port on the encoder back panel. Connect the R- and R+ terminals of the PTZ camera or PTZ dome to the RS-485 T- and RS-485 T+ terminals respectively.

Configure the RS-485 parameters in the **Configuration > Remote Configuration > Serial Port Settings > 485 Serial Port** menu.

### Presets

Presets are previously defined locations of a PTZ dome camera. They allow you to quickly move the PTZ dome camera to a desired position. Up to 256 presets can be configured.

#### To set up a preset:

1. In live view mode, select a preset from the preset list.

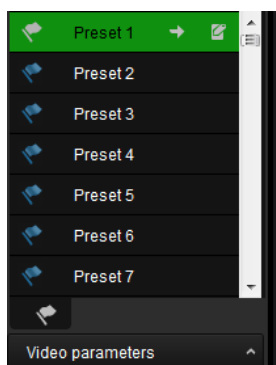

2. Use the directional, zoom, focus and iris buttons to position the camera in the desired preset location.

3. Click  to save the position.

### To call up a preset:

1. In live view mode, select a camera.
2. Select a preset from the preset list.
3. Click . The camera immediately moves to that preset position.

## Video image settings

You can manually adjust the brightness, contrast, saturation, hue, sharpness and denoising values of the camera image to get the best image quality.

1. In the live view window, click the **Video Parameters** button on the bottom right corner to display the Video Parameters Setting window:



2. Move the slider to adjust the brightness, contrast, saturation, hue, sharpness and denoising. Changes are automatically saved.

# Configuration

## Local configuration

Local configuration lets you define communication and network parameters such as protocol type, maximum file size, stream type, and network transmission settings. You can also specify the directory locations for saving recorded and playback video, captured images, and downloaded files.

### To configure video loss detection:

1. Click **Configuration > Local Configuration**. The Local Configuration window appears.

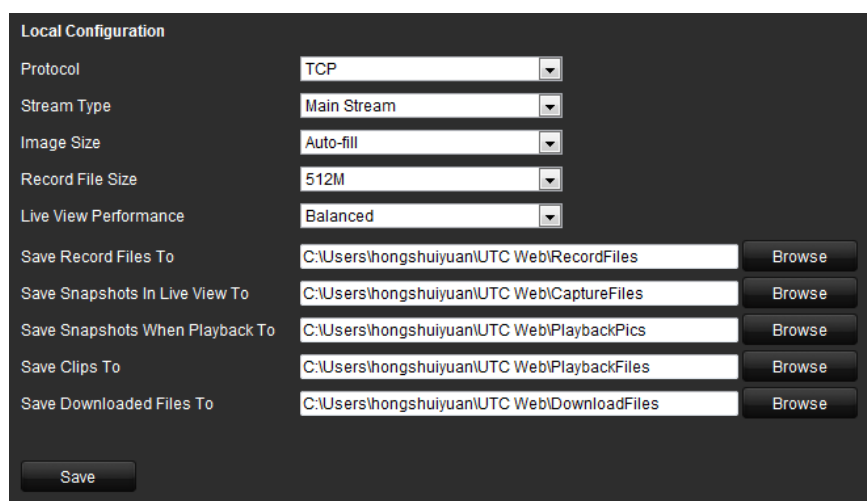

The screenshot shows the 'Local Configuration' window with the following settings:

Setting	Value
Protocol	TCP
Stream Type	Main Stream
Image Size	Auto-fill
Record File Size	512M
Live View Performance	Balanced
Save Record Files To	C:\Users\hongshuiyuan\UTC Web\RecordFiles
Save Snapshots In Live View To	C:\Users\hongshuiyuan\UTC Web\CaptureFiles
Save Snapshots When Playback To	C:\Users\hongshuiyuan\UTC Web\PlaybackPics
Save Clips To	C:\Users\hongshuiyuan\UTC Web\PlaybackFiles
Save Downloaded Files To	C:\Users\hongshuiyuan\UTC Web\DownloadFiles

A 'Save' button is located at the bottom left of the window.

2. Enter the required values.

**Protocol:** Set the protocol type of stream transmission to TCP or UDP. UDP provides more real-time audio and video streams. TCP ensures the complete deliver of streaming data and better video quality but it may not always be reliable for real-time delivery.

**Stream Type:** Select the stream type (main stream or substream) to be used for live view by the web browser.

**Image Size:** Select the window-division view mode to 4:3, 16:9, or Auto-fill.

**Record File size:** Select the size of packed video files during manual recording to 256M, 512M or 1G.

**Live View Performance:** Set the live viewing performance to Shortest Delay, Balanced (delay and fluency), Real Time, or Fluency.

**Save Record Files To:** Set the saving path for the manually recorded video files.

**Save Snapshots In Live View To:** Set the saving path for the manually captured pictures in live view mode.

**Save Snapshots When Playback To:** Set the saving path for the captured pictures in playback mode.

**Save Clips To:** Set the saving path for the clipped video files in playback mode.

**Save Downloaded Files To:** Set the saving path for the downloaded video files or pictures.

3. Click **Save** to save the settings.

### Windows users

Internet Explorer for Windows operating systems have increased security measures to protect your PC from any malicious software being installed.

To have complete functionality of the web browser interface with Windows, do the following:

- Run the browser interface as an administrator in your workstation
- Add the camera's IP address to your browser's list of trusted sites

#### To add the camera's IP address to Internet Explorer's list of trusted sites:

1. Open Internet Explorer.
2. Click **Tools**, and then **Internet Options**.
3. Click the **Security** tab, and then select the Trusted sites icon.
4. Click the **Sites** button.
5. Clear the "Require server verification (https:) for all sites in this zone" box.
6. Enter the IP address in the "Add this website to the zone" field.
7. Click **Add**, and then click **Close**.
8. Click **OK** in the Internet Options dialog window.
9. Connect to the camera for full browser functionality.

### Time settings

You can set the date and time that will appear on-screen and on time stamped recordings. The start and end times of daylight savings time (DST) in the year can also be set.

A Network Time Protocol (NTP) server can also be set up on your encoder to keep the date and time current and accurate. If the encoder is connected to a Dynamic Host Configuration Protocol (DHCP) network that has time server properties configured, the cameras will synchronize automatically with the time server.

#### To configure time settings:

1. Click **Configuration > Remote Configuration > Device Parameters > Time Settings**. The Time Settings window appears.

2. Select the time zone.

Select the time zone that is closest to the device's location from the drop-down list.

3. Configure the time synchronization method: NTP server or manually.

**Configuring time sync by NTP server:** Check the **NTP** box. Enter the IP address and port of the NTP server.

**Note:** If the encoder is connected to a public network, you should use a NTP server that has a time synchronization function, such as the server at the National Time Center (IP Address: 210.72.145.44) or europe.ntp.pool.org. If the encoder is set up in a more customized network, NTP software can be used to establish a NTP server used for time synchronization.

**Configuring time synchronization manually:** Check the **Manual Time Sync** box. Click the **Set Time** icon to set the system time from the pop-up calendar. You can check the **Sync with computer time** checkbox to synchronize the time with the local PC.

4. Configure the DST settings, if required.

Check the **Enable DST** box. Set the start time and end time of DST period. The end time must be later than the start time. When the DST period ends, the system reverts to the standard local time. Set the DST bias to 30 min, 60 min, 90 min or 120 min.

5. Click **Save** to save the settings.

## Network set up

You must configure your encoder's network settings before using it over the network.

**Table 1: Encoder network functions**

Function	Description
TCP/IP	Configure general network settings such as NIC type, IPv4 address, IPv4 subnet mask, IPv4 default gateway, MAC address and MTU. You can also configure the DNS server.
DDNS	If the encoder is set up to use PPPoE as its default network connection, configure the Dynamic DNS (DDNS) to be used in conjunction. You need to register with your ISP before configuring your system for use with DDNS.
Email	Configure the encoder to send email notifications of alarms or notifications through the network. <b>Note:</b> Ensure that the DNS address has been set up correctly beforehand.
SNMP	This is an internet-standard protocol for managing devices on IP networks. Configure this protocol to allow information on the encoder status as well as event and alarm notifications to be sent to a surveillance center. Before configuring this function, you must first install the SNMP software.
Port	Configure the port number of the encoder, For example, HTTP port, RTSP port or HTTPS port.
FTP	Configure the FTP settings. Snapshots can be uploaded to an FTP server.
NetHDD	Configure the network disk before operating the recording, playback, or log searching.
PPPoE	If the encoder is directly connected to an ADSL modem, configure the PPPoE settings. Contact your ISP to get the user name and password.
QoS	Configure the QoS (Quality of Service) to help solve the network delay and network congestion by configuring the priority of data sending. The use of a QoS-aware network can prioritize traffic and thus allow critical flows to be served before flows with lower priority.
SOCKS	SOCKEt Secure (SOCKS) is an Internet protocol that routes network packets between a client and server through a proxy server. This feature is useful if the encoder is located on a local network behind a firewall, and Email notifications, FTP uploads, alarms, and such need to be sent to a destination outside the local network (such as the Internet).
NAT	A NAT (Network Address Translation) is used for network connection. Select the port mapping mode: Auto or Manual.
HTTPS	HTTPS (Hyper Text Transfer Protocol Secure) ensures the data transferred is encrypted using Secure Socket Layer (SSL) or Transport Layer Security (TLS). HTTPS provides authentication of the web site and associated web server that one is communicating with and create a secure channel over an insecure network.
Bonjour	Bonjour is enabled by default and the video encoder can be automatically detected by operating systems and clients that support this protocol.
IP Address Filter	You can allow or forbid access by specified IP addresses to the encoder by enabling IP Address Filter.
802.1x	The IEEE 802.1X standard is supported by the network cameras, and when the feature is enabled, the camera data is secured and user authentication is needed when connecting the camera to the network protected by the IEEE 802.1X.
Advanced	Configure the multicast address, remote alarm host and Telnet.

## To configure TCP/IP settings:

1. Click **Configuration > Remote Configuration > Network Settings > TCP/IP**. The TCP/IP window appears.

The screenshot shows a configuration window for TCP/IP settings. The window is titled "TCP/IP" and has a "NIC Settings" section. The settings are as follows:

Field	Value
NIC Type	Auto
IPv4 Address	10.18.5.40
IPv4 Subnet Mask	255.255.255.0
IPv4 Default Gateway	10.18.5.254
IPv6 Address	fe80::8ee7:48ff:fe5f:9504
IPv6 Default Gateway	
Mac Address	8c:e7:48:5f:95:04
MTU	1500

Below the NIC Settings section is the DNS Server section:

Field	Value
Preferred DNS Server	10.1.7.88
Alternate DNS Server	10.1.7.77

A "Save" button is located at the bottom left of the window.

2. Enter the required settings:

Option	Description
NIC Type	Network interface card (NIC) is a device used to connect the encoder to a network. Select the NIC type used from the drop-down list. Default value is Auto.
Enable DHCP	Check this box if you have a DHCP server running and want your encoder to automatically obtain an IP address and other network settings from that server. Default value is Disable.
IPv4 Address	Enter the IP address for the encoder. Default value is 192.168.1.70.
IPv4 Subnet Mask	Enter the subnet mask for your network so the encoder will be recognized within the network. Default value is 255.255.255.0.
IPv4 Default Gateway	Enter the IP address of your network gateway so the encoder will be recognized within the network. This is typically the IP address of your router. Default value is 0.0.0.0.
IPv6 Address	Display IPv6 address for the encoder.
IPv6 Default Gateway	Display the IPv6 address of your network gateway so the encoder will be recognized within the network. This is typically the IP address of your router.
MAC Address	Display the MAC address.
MTU (bytes)	Enter a value between 500 and 1500. Default is 1500.
Preferred DNS Server	Enter the preferred domain name server to use with the encoder.
Alternate DNS Server	Enter the alternate domain name server to use with the encoder.

3. Click **Save** to save the settings.

#### To configure PPPoE settings:

1. Click **Configuration > Remote Configuration > Network Settings > PPPoE**. The PPPoE window appears.
2. Check **Enable PPPoE**.
3. Enter your user name and password and confirm the password.  
**Note:** The user name and password should be assigned by your ISP.
4. Click **Save** to save the settings.

#### To set up DDNS:

1. Click **Configuration > Remote Configuration > Network Settings > DDNS**. The DDNS settings window appears.
2. Check **Enable DDNS**.
3. Select one of the three DDNS types listed:
  - **DynDNS:** Enter the server address for DynDNS (i.e. members.dyndns.org). In the DVR Domain Name field, enter the domain obtained from the DynDNS web site. Then enter the user name and password registered in the DynDNS network.
  - **IP server:** Enter the server address for IP Server.
  - **ezDDNS:** Enter the host name. It will automatically register it online.
4. Click **Save** to save the settings.

#### To configure Email settings:

1. Click **Configuration > Remote Configuration > Network Settings > TCP/IP** to set the IPv4 Address, IPv4 Subnet Mask, IPv4 Default Gateway and the Preferred DNS Server.
2. Click the **Configuration > Remote Configuration > Network Settings > Email**. The Email Settings window appears.
3. Check **Authentication** if your mail server requires authentication. Enter the login user name and password.
4. Enter the required settings.

Option	Description
Authentication	If your mail server requires authentication, check this checkbox to use authentication to log in to this server and enter the login User Name and Password.
SMTP server	Enter the SMTP server's IP address.
SMTP port	Enter the SMTP port. The default TCP/IP port for SMTP is 25.
Enable SSL	Check the box to enable SSL if it is required by the SMTP server. This feature is optional.



Option	Description
Interval	The interval represents the time range in between the alarm images being sent. For example, if you set the interval at two seconds, the second alarm image will be sent two seconds after the first alarm image.
Attached Snapshot	Check the box if you want to send email with attached alarm JPEG images.
Sender	Enter the name of the sender of the email.
Sender's address	Enter the sender's email address.
Choose receiver	Select an email recipient. Up to three receivers can be selected.
Receiver	Enter the name of the receiver of the email.
Receiver's address	Enter the email address of the receiver.

5. Click **Test** to the test email settings.

**Note:** We recommend that you test the email settings after entering values in the email window.

6. Click **Save** to save the settings.

#### To configure NetHDD settings:

**Note:** Ensure that the network storage device is available within the network and is properly connected. Also the network storage device must be configured with NAS or IP SAN mode.

1. Click **Configuration > Remote Configuration > Network Settings > NetHDD**. The NetHDD window appears.
2. Enter the IP address of the network storage system and file path in the text field.
3. Select the type of the network storage system: IP SAN or NAS.

**NAS mode:** Enter the IP address of the storage device.

**IP SAN mode:** Enter the IP address of the storage device.

**Note:** Under **File Path**, enter the file path name to define where on the remote storage system you want to store the files. If using a NAS storage system, you must add the prefix “/nfs” or “nfs V3” to the NAS path. No credentials are required.

4. Click **Save** to add the configured network disk.
5. Initialize the added network disk.

Click **Remote Configuration > Storage Management > Basic Settings** to enter the HDD settings menu. The capacity, free space, status, type and property of the added network disk are displayed.

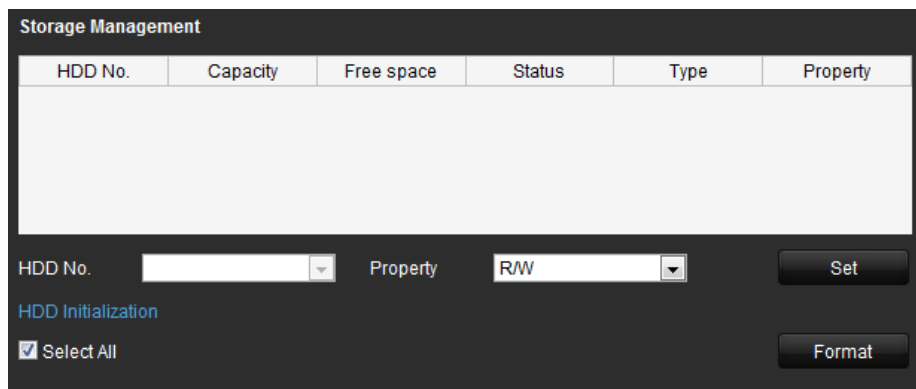

If the status of the network disk is Uninitialized, select the disk and click **Format** to start initializing it. When the initialization is complete, the disk status becomes Normal.

**Note:** Up to 8 NAS or IP SAN disk can be connected to the encoder.

- Set the property of the added network disk.

Select the HDD number. Select its property from the drop-down menu: R/W, Read-only or Redundancy.

**Note:** Please refer to the IP SAN/NAS user manual on how to create a file path in network management.

The tested brands for the storage system are:

- Iomega StorCenter ix2-dl
- QNAP TS-219 II Turbo NAS
- QNAP TS-220/221

### To configure SNMP protocol settings:

- Click **Configuration > Remote Configuration > Network Settings > SNMP**. The SNMP window appears.

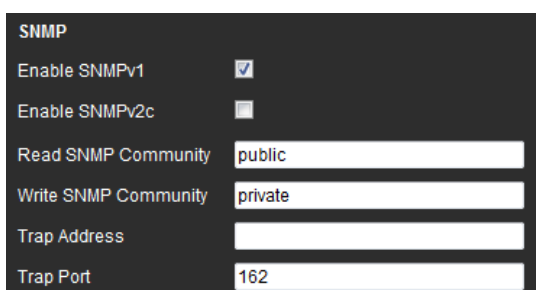

- Check the checkbox to enable SNMP v1 or SNMP v2c, and configure the read SNMP community (default: public), write SNMP community (default: private), trap address (default: empty) and trap port (default: 162). You can also enable both SNMP v1 and SNMP v2c.
- When the SNMPv3 is enabled, you can configure the read username (default: public).

**Note:** SNMPv1, SNMP v2c and SNMPv3 are disabled by default.

4. Select the security level to “no auth, no priv”, “auth, no priv”, “no auth, priv” or “auth, priv”.

Enable SNMPv3

Read UserName: public

Security Level: auth, priv

Authentication Algorithm:  MD5  SHA

Authentication Password: .....

Private-key Algorithm:  DES  AES

Private-key Password: .....

Write UserName: private

Security Level: auth, priv

Authentication Algorithm:  MD5  SHA

Authentication Password: .....

Private-key Algorithm:  DES  AES

Private-key Password: .....

SNMP Port: 161

Save

5. When the security level is set to “auth, priv”, configure the Authentication Algorithm and Privacy Algorithm parameters.

When the security level is set to “no auth, no priv”, the Authentication Algorithm and Privacy Algorithm parameters cannot be configured.

6. Click **Save** to save the settings.

#### To configure Port settings:

1. Click **Configuration > Remote Configuration > Network Settings > Port**. The Port window appears.

Port

HTTP Port: 80

RTSP Port: 554

HTTPS Port: 443

Save

2. Set the HTTP port, RTSP port and HTTPS port of the encoder.

**HTTP Port:** The default port number is 80.

**RTSP Port:** The default port number is 554.

**HTTPS Port:** The default port number is 443.

3. Click **Save** to save the settings.

**Note:** It will ask you to reboot the device to activate the settings.

#### To configure QoS settings:

1. Click the **Configuration > Remote Configuration > Network Settings > QoS**. The QoS window appears.

2. Check the checkbox to enable the QoS function.
3. Enter the DSCP (Differentiated Services Codepoint) value for the video/audio, event/alarm and management traffic. This value is used to mark the traffic's IP header. The DSCP value defines the priority level for the specified type of traffic, for example, how much bandwidth to reserve for it.

The valid value range of the DSCP is 0-63. The higher DSCP value indicates higher priority level.

4. Click **Save** to save the settings.

**Note:** It will ask you to reboot the device to activate the settings.

### To configure FTP settings:

1. Click **Configuration > Remote Configuration > Network Settings > FTP**. The FTP window appears.

2. Check the **Enable FTP** checkbox.
3. Configure the FTP settings, including server address, port, user name, password, directory, and upload type.

**Directory:** In the Directory Structure field, you can select the root directory, parent directory and child directory. When the parent directory is selected, you have the option to use the Device Name, Device Number or Device IP for the name of the directory; and when the Child Directory is selected, you can use the Camera Name or Camera Number as the name of the directory.

**Upload type:** To enable uploading snapshots to the FTP server.

4. Click **Save** to save the settings.

**Note:** If you want to upload the captured pictures to FTP server, you have to configure snapshot settings on Snapshot page. For detailed information, please refer to Snapshot Settings section.

#### To configure SOCKS settings:

1. Click the **Configuration > Remote Configuration > Network Settings > SOCKS**. The SOCKS window appears.

**SOCKS**

Enable SOCKS

Server: 10.18.5.134

Server Port: 1080

Server Type: SOCKS5

User Name: tve

Password: \*\*\*\*\*

Confirm: \*\*\*\*\*

Local networks:  Use semicolon(;) to separate local networks, use slash (/) to separate ip address and network mask, example: 192.168.1.2/255.255.255.0;192.168.1.3/255.255.255.0

**Save**

Configure the following settings:

**Server:** Enter the address of the SOCKS server.

**Server Port:** Enter the port of the SOCKS server (default: 1080).

**Server Type:** Select the server type to SOCKS4 or SOCKS5. When you select SOCKS5, you can enable the user authentication on the server and then enter the login user name and password here.

**Local Networks:** Define the local network segment that does not need to use the SOCKS proxy server. You can enter multiple network addresses and use the semicolon (;) to separate them, e.g., 10.0.0.0/255.0.0.0; 172.16.0.0/255.240.0.0.

2. Click **Save** to save the settings.

#### To configure NAT settings:

1. Click the **Configuration > Remote Configuration > Network Settings > NAT**. The NAT window appears.

**NAT**

Enable UPnP

Port Mapping Mode:

**Port Mapping**

HTTP Port:

Server Port:

RTSP Port:

HTTPS Port:

**Port Status**

Protocol Name	Enable	External Port	Router LAN IP	External IP Address	Status
HTTP	No	80	0.0.0.0	0.0.0.0	Not Valid
RTSP	No	554	0.0.0.0	0.0.0.0	Not Valid
HTTPS	No	443	0.0.0.0	0.0.0.0	Not Valid
SDK	No	8000	0.0.0.0	0.0.0.0	Not Valid

2. Check the checkbox to enable the UPnP function.
3. Select the **Port Mapping Mode** to Auto or Manual.

If you select *Auto*, the mapping ports can be automatically assigned by the router.

If you select *Manual*, go to Step 4 to edit the mapping ports.

4. Configure the HTTP Port (for access by WEB browser), SDK Port Mapping (for access by client software), RTSP Port and HTTPS Port respectively.

**Notes:**

- 1) You can use the default port number, or change it according to actual requirements.
  - 2) The ports indicate the port number for mapping in the router.
5. Click **Save** to save the settings.

After port mapping is successful, you can view the status of the port mapping in the *Port Status* area.

**NAT**

Enable UPnP

Port Mapping Mode:

**Port Mapping**

HTTP Port:

Server Port:

RTSP Port:

HTTPS Port:

**Port Status**

Protocol Name	Enable	External Port	Router LAN IP	External IP Address	Status
HTTP	No	80	0.0.0.0	0.0.0.0	Not Valid
RTSP	No	554	0.0.0.0	0.0.0.0	Not Valid
HTTPS	No	443	0.0.0.0	0.0.0.0	Not Valid
SDK	No	8000	0.0.0.0	0.0.0.0	Not Valid

## To configure HTTPS settings:

1. Click the **Configuration > Remote Configuration > Network Settings > HTTPS**. The HTTPS window appears.
2. Create the self-signed certificate or authorized certificate (see steps below).

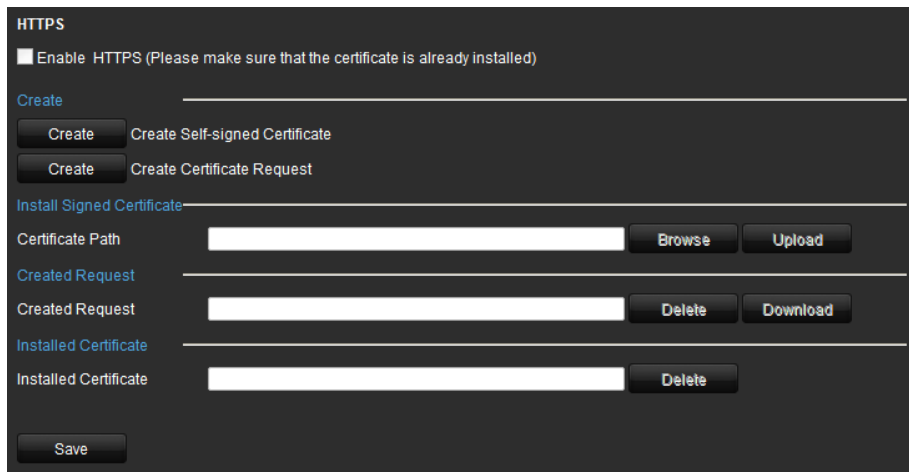

### Create the self-signed certificate

1. Click the **Create** button to create the following dialog box.  
Enter the country, host name/IP, validity and other information.

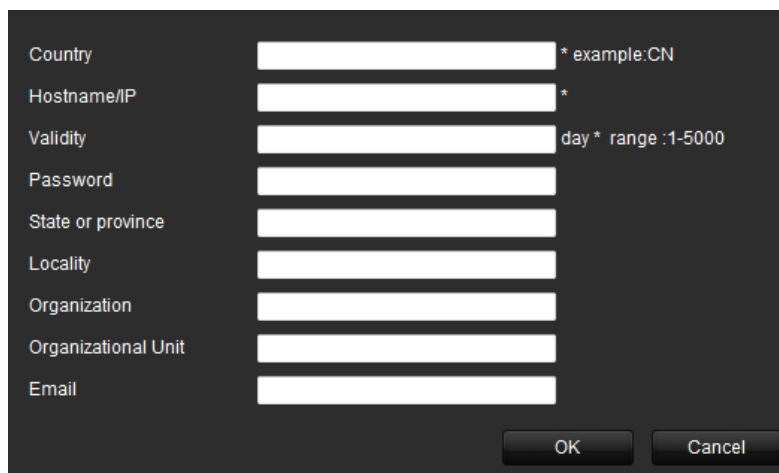

2. Click **OK** to save the settings.

### Create the authorized certificate

1. Click the **Create** button to create the certificate request.
2. Download the certificate request and submit it to the trusted certificate authority for signature.
3. After receiving the signed valid certificate, import the certificate to the device.
4. When you have successfully created and installed the certificate, check the checkbox to enable the HTTPS function.

**Note:** After the HTTPS feature is enabled, the system will use the HTTPS login mode by default when you input the IP address (e.g., `https://192.0.0.64`). You can also input `http://IP address/index.asp` (e.g.,

http://192.0.0.64/index.asp) if you want to use HTTP mode to log into the device.

### To configure Bonjour settings:

1. Click the **Configuration > Remote Configuration > Network Settings > Bonjour**. The Bonjour window appears.

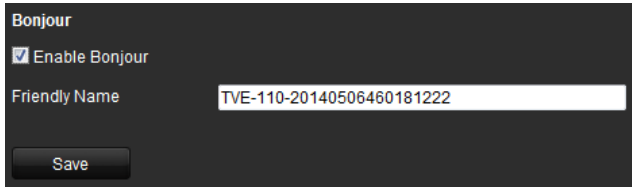

2. Check the checkbox to enable the Bonjour function.
3. Edit the name of device. The name is shown when the device is detected by the system.

**Note:** Only the letters, numbers and “-” can be contained in the name.

4. Click **Save** to save the settings.

### To configure IP Address Filter settings:

1. Click the **Remote Configuration > Network Settings > IP Address Filter**. The IP Address Filter window appears.



2. Check the checkbox of Enable IP Address Filter.
3. Select the filter type of IP address to Allowed or Forbidden.
4. Click the **Add** button and add the IP address to be allowed or forbidden. Click **OK**.

**Note:** Up to 256 IP address can be added to the list (allowed/forbidden) by web browser.



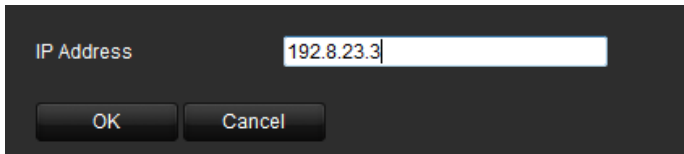

5. Click **Save** to save the settings.

#### To configure Multicast Address settings:

1. Click the **Remote Configuration > Network Settings > Advanced**. The Advanced window appears.

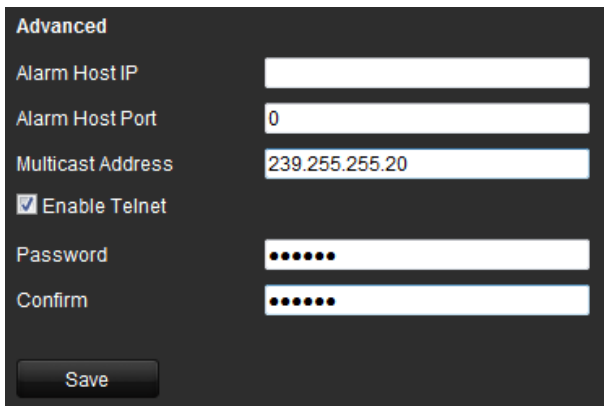

2. Enter the multicast address in the text field.
3. Click **Save** to save the settings.

**Note:** The device will reboot automatically to activate the multicast address settings.

#### To configure Remote Alarm Host settings:

1. Click the **Configuration > Remote Configuration > Network Settings > Advanced**. The Advanced window appears.

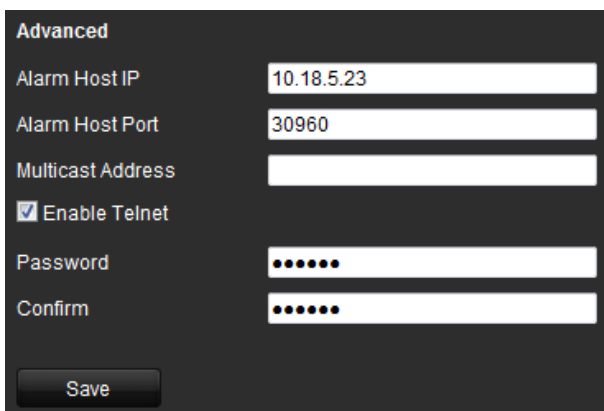

2. Enter the alarm host IP and alarm host port values.

The Alarm Host IP refers to the IP address of the remote PC on which the CMS (Client Management System) software is installed, and the Alarm Host Port must be the same as the alarm monitoring port configured in the software (default port is 7200).

3. Click **Save** to save the settings.

### To configure IEEE 802.1X settings:

1. Click the **Configuration > Remote Configuration > Network Settings > 802.1X**. The 802.1X window appears.

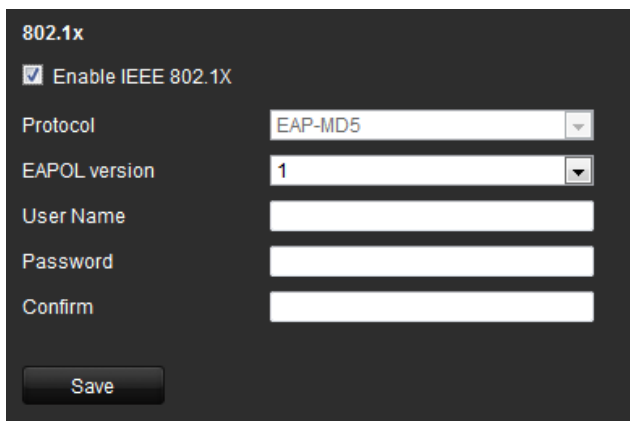

2. Check the **Enable IEEE 802.1X** checkbox to enable the feature.
3. Configure the 802.1X settings, including EAPOL version, user name and password.

**Note:** The EAPOL version must be identical with that of the router or the switch.

4. Enter the user name and password to access the server.
5. Click **Save** to save the settings.

## Camera set up

You can configure which information is displayed on-screen. The on-screen display (OSD) settings appear in live view and recording modes and include the camera name, time and date. You can also adjust the transparency of the OSD relative to the background so that it is easier to read or is less prominent on screen.

You can add up to eight lines of text on screen. This option can be used, for example, to display emergency contact details.

### To configure the OSD settings:

1. Click the **Configuration > Remote Configuration > Camera Settings > Display Settings**. The Display Setting window appears.

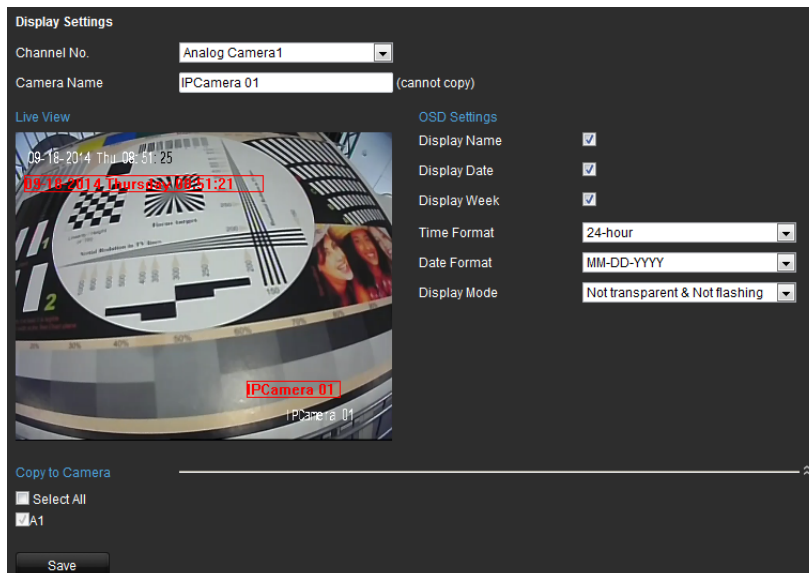

2. Select a camera from the drop-down list.
3. Edit the camera name in **Camera Name**.
4. Select the display of camera name, date or week by checking the checkboxes if required.
5. Set the time format, date format and OSD display mode by selecting option from the drop-down list.
6. On the live image, you can adjust the OSD location on the screen by moving the text frame.
7. If you want to copy the display settings of the current camera to other cameras, go to the **Copy to Camera** panel and select the camera(s) to copy, or click **Select All** to select all cameras.
8. Click **Save** to save the settings.

#### To add a text overlay:

1. Click the **Configuration > Remote Configuration > Camera Settings > Text Overlay**. The Text Overlay Setting window appears.
2. Select the camera from the drop-down list.
3. Edit the user-defined text content.  
Click the checkbox in the text box below and then input the characters. Up to eight character strings can be edited.
4. Click **Save**. The edited text is shown on the image.
5. On the preview image, you can adjust the Text location on the screen by moving the text frame.

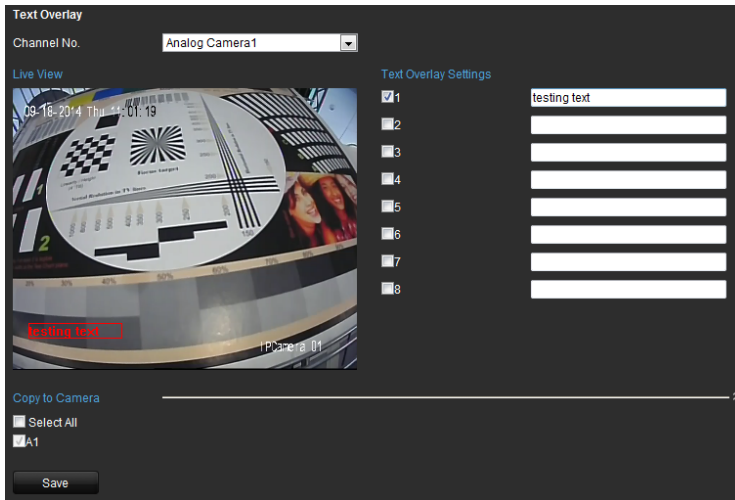

6. If you want to copy the display settings of the current camera to other cameras, go to the **Copy to Camera** panel and select the camera(s) to copy, or click **Select All** to select all cameras.
7. Click **Save** to save the settings.

## Video streaming set up

You can adjust the video streaming parameters to obtain the image quality and file size best suited to your needs.

### To configure video settings:

1. Click **Configuration > Remote Configuration > Camera Settings > Video Settings**. The Video Setting window appears.

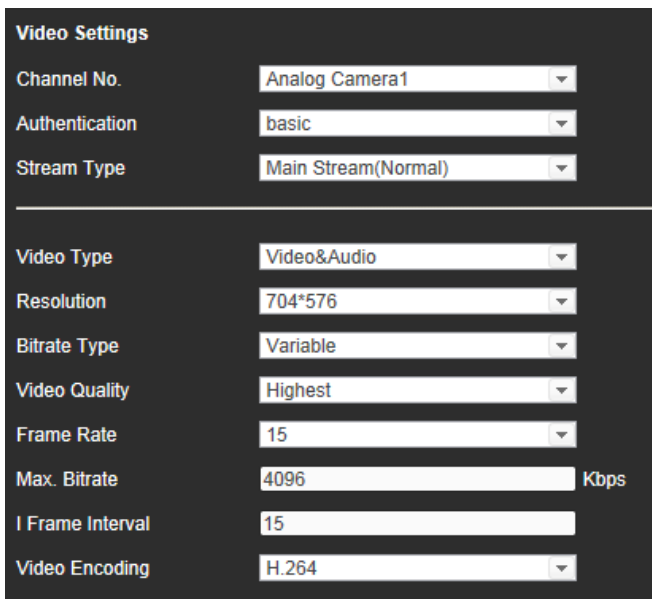

2. Select a camera from the drop-down list.
3. Enable RTSP authentication by selecting the **Authentication** to basic, or disable it.

4. Select the **Stream Type** of the camera to Main Stream (Normal), Main Stream (Event) or Sub Stream.

The main stream is usually for recording and live viewing with good bandwidth, and the substream can be used for live viewing when the bandwidth is low. Refer to “Local configuration” on page 15 on changing the main stream to substream for live viewing.

5. You can customize the following parameters for the selected Main Stream or Sub Stream:

**Video Type:** Select the video type to video stream, or video & audio composite stream. The audio signal will be recorded only when the Video Type is Video & Audio.

**Resolution:** Select the resolution of the video input.

**Bitrate Type:** Select the bitrate type to constant or variable.

**Video Quality:** When bitrate type is selected to *Variable*, six levels of video quality can be configured.

**Frame Rate:** Set the frame rate between 1/16 and 25 fps / 30 fps.

The frame rate used to describe the frequency at which a video stream is updated is measured in frames per second (fps). A higher frame rate is advantageous when there is movement in the video stream, as it maintains image quality throughout.

**Max. Bitrate:** Set the Max. bitrate between 32 and 8192 Kbps.

**I Frame Interval:** Set the I frame interval between 1 and 400 (frames). The higher value results in lower video quality.

**Video Encoding:** Select the video encoding standard to H.264, MPEG4 or MJPEG.

6. If you want to copy the display settings of the current camera to other cameras, go to the **Copy to Camera** panel and select the camera(s) to copy, or click **Select All** to select all cameras.
7. Click **Save** to save the settings.

#### To configure Snapshot:

1. Click **Configuration > Configuration > Camera Settings > Snapshot**. The Snapshot Setting window appears.

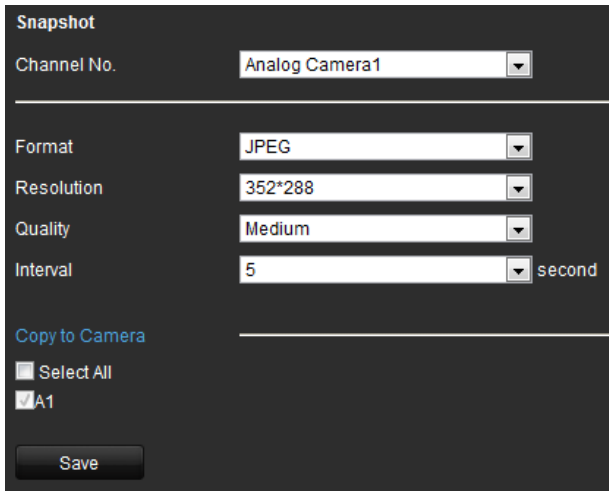

2. Select the channel number from which the pictures are to be captured.
3. Configure the snapshot parameters, including the format, resolution, quality, and the interval between two snapshots.
4. Select the channel (s) to which you want to copy the same settings, if needed.
5. Click **Save** to save the settings.

## Motion detection

The encoder can be set up to trigger an alarm if it detects motion, which can then be recorded such as on a network storage device. You can then search these recorded motion activities for specific incidents.

Select the level of sensitivity to motion so that only objects that could be of interest can trigger a motion recording. For example, recording is triggered by the movement of a person but not that of a cat.

### To configure motion detection:

1. Click **Configuration > Remote Configuration > Camera Settings > Motion Detection**. The Motion Detection window appears.

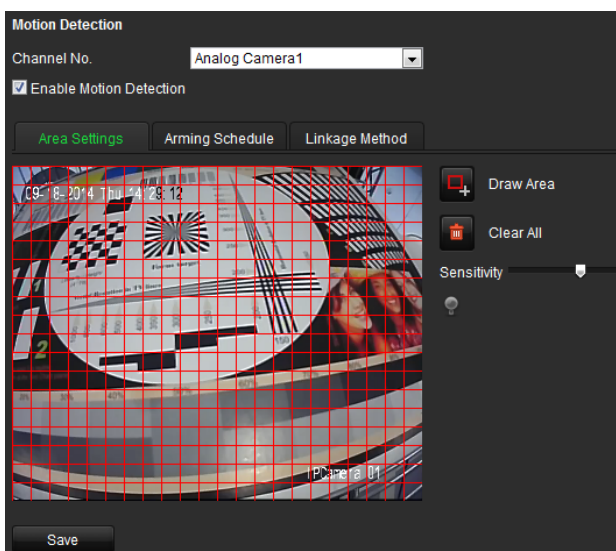

2. Select a camera from the drop-down list. Each camera must be set up individually.
3. Check **Enable Motion Detection**.
4. **Select the area sensitive to motion and the sensitivity level.**

Click **Draw Area**. Click and drag the mouse cursor across the screen. The area selected appears as a red grid. Areas covered by the red grid are sensitive to motion detection. Up to eight areas can be drawn. Click **Stop Drawing** when completed. Click **Clear All** to clear the screen.

Drag the Sensitivity scroll bar to the desired sensitivity level. The highest value is on the right of the bar.

Click **Save** to save the settings.

Check the **Enable Dynamic Analysis** checkbox to enable motion detection. When enabled, the motion detection triggered frame (green) for the moving targets in the motion detection area will be displayed on the live video.

5. **Select the recording schedules for motion detection.**

Click the **Arming schedule** tab. Click **Edit**.

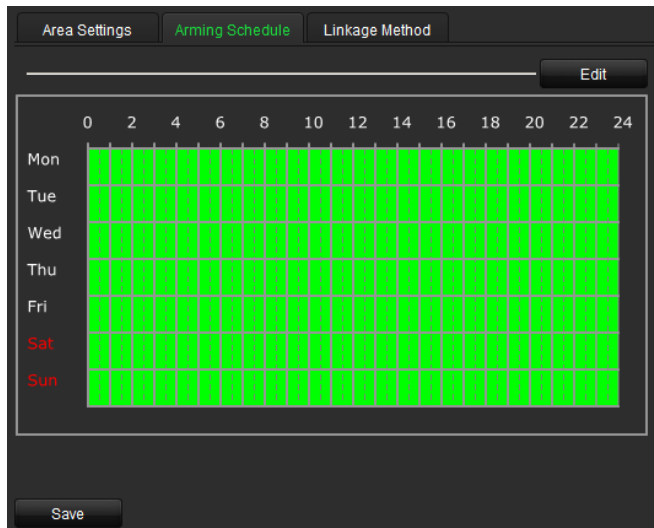

Select the day of the week when motion can be recorded. Click  to set the time periods for the arming schedule during the day. You can schedule up to eight time periods in a day. Default is 24 hours. Click **OK**.

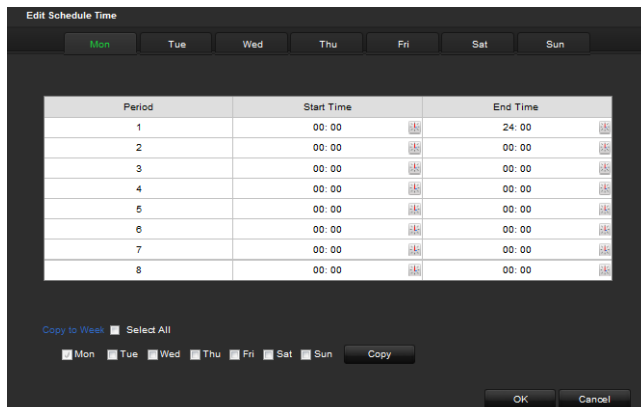

**Note:** Time periods defined cannot overlap.

6. **Select the response method to motion detection.**

Click the **Linkage Method** tab.

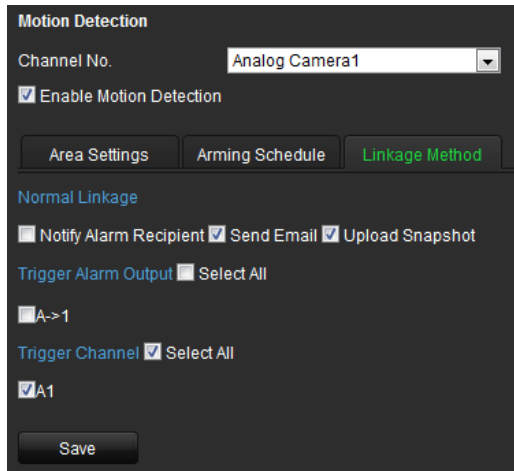

Under **Alarm Linking**, check one or more of the desired response methods:

- **Notify Alarm Recipient:** Send a notification or alarm signal to remote alarm host when an event occurs. The alarm host refers to the computer installed with remote client software
- **Send Email:** Send an email with alarm information to a user or users when an event occurs.
- **Upload Snapshot:** Capture the image when an alarm is triggered and upload the picture to a FTP server.

Under **Trigger Alarm Output** select the channel to trigger an external alarm output when a motion detection event occurs. See “To set up an alarm output” below on how to set up an external alarm output.

Select the channel to trigger recording when a motion detection event occurs.

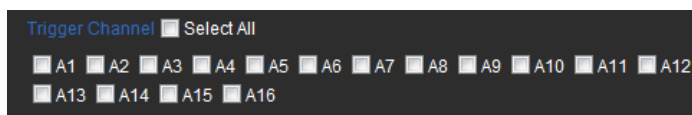

7. Click **Save** to save settings.

## Alarm settings

The encoder can be configured to record when an alarm is triggered by an external alarm device (for example, PIR detector, dry contacts...).

### To configure alarm inputs:

1. Click **Configuration > Remote Configuration > Alarm Settings > Alarm Input**. The Alarm Input Settings window appears.



The screenshot shows the 'Alarm Input Settings' window. At the top, there are fields for 'Alarm Input No.' (set to 'A<-1'), 'Alarm Name' (with a '(cannot copy)' note), and 'Alarm Type' (set to 'NO'). There is an 'Enable' checkbox which is checked. Below these are two tabs: 'Arming Schedule' (highlighted in green) and 'Linkage Method'. The 'Arming Schedule' tab contains a grid with days of the week (Mon-Sun) on the y-axis and hours (0-24) on the x-axis. All cells in the grid are filled with green, indicating the alarm is armed 24/7. An 'Edit' button is located at the top right of the grid. At the bottom left, there is a 'Copy to Alarm' link, and at the bottom center, there is a 'Save' button.

2. Select the alarm input number of a camera.
3. Select the alarm input type, NO or NC.
4. Set the arming schedule for the alarm input.
5. Select the response method to motion detection.

Click the **Linkage Method** tab. Under **Normal Linkage**, check one or more of the desired the response methods:

- **Notify Alarm Recipient:** Send a notification or alarm signal to remote alarm host when an event occurs. The alarm host refers to the computer installed with remote client software
- **Send Email:** Send an email with alarm information to a user or users when an event occurs.
- **Upload Snapshot:** Capture the image when an alarm is triggered and upload the snapshot to an FTP server.

Under **Trigger Alarm Output**, select the channel to trigger an external alarm output when a motion detection event occurs. See “To configure an alarm output” below on how to set up an external alarm output.

Select the channel to trigger recording when a motion detection event occurs.

If the camera is PTZ, select PTZ linking.

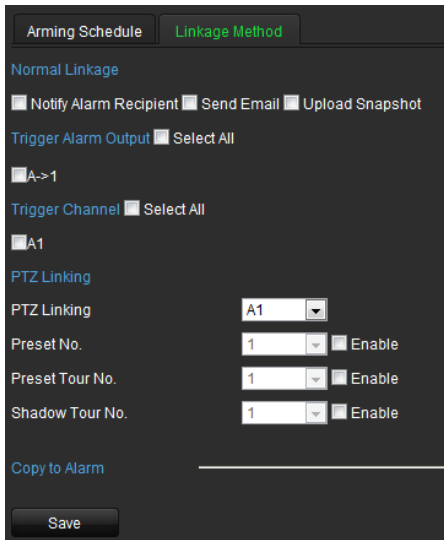

6. Click **Save** to save settings.

**To configure an alarm output:**

1. Click **Configuration > Remote Configuration > Alarm Settings > Alarm Output**. The Alarm Output Settings window appears.

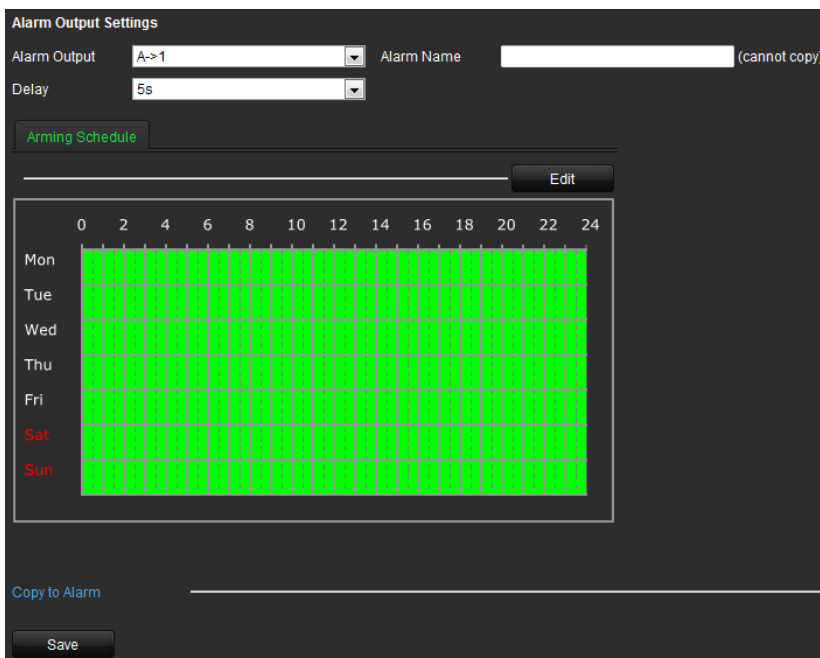

2. Select an alarm output.
3. Select a delay option.

The Delay setting lets you define how long a signal remains active after the alarm has ended. Select a time out option: 5, 10, and 30 seconds, 1, 2, 5, and 10 minutes, and Manual clear. If “Manual clear” is selected, the alarm output will stop only when the alarm input stops.

4. Select the recording schedules for the alarm output.

Click **Edit**. In the **Edit Schedule Time** window select the day of the week and the time periods during the day when motion can be recorded. You can schedule up to eight time periods in a day. Default is 24 hours.

Click **Save** to save the settings.

**Note:** The time periods defined cannot overlap.

5. Click **Save** to save settings

## Video Loss

Video may be lost if the video cable or camera develops a fault or is damaged. You can set up your encoder to detect video loss and trigger a system notification.

**To configure video loss detection:**

1. Click **Configuration > Remote Configuration > Camera Settings > Video Loss**. The Video Loss window appears.

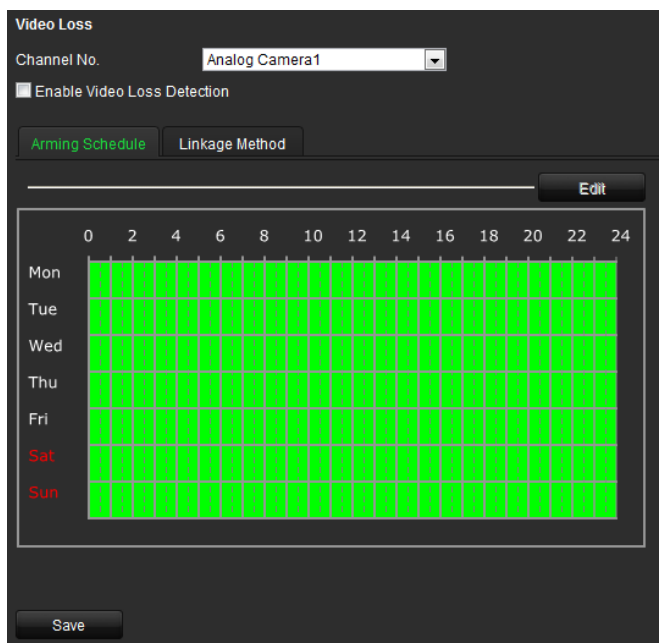

2. Select a camera to configure for video loss detection.
3. Check the **Enable Video Loss Detection** box.
4. Under the **Arming Schedule** tab, click **Edit** to modify the arming schedule for video loss detection. The configuration is the same as that for the arming schedule for motion detection.
5. Select the **Linking Method** tab. Then select the response method to notify you of the alarm.
6. Click **Save** to save the settings.

## Tamper-proof alarm

Video tampering, such as moving a camera to a different position, can also be detected and set to trigger an action on the encoder.

**Note:** It is strongly recommended not to configure for video tampering when using PTZ dome cameras.

### To configure tamper-proof detection:

1. Click **Remote Configuration > Camera Settings > Tamper-proof**. The Tamper-proof window appears.

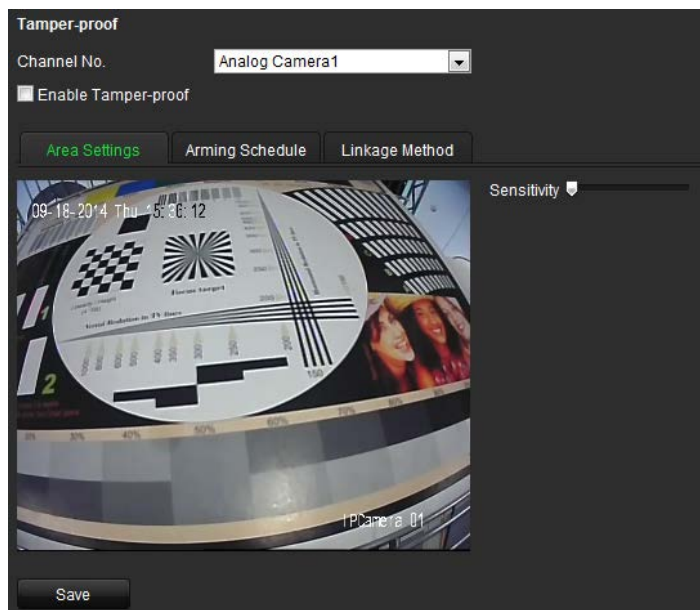

2. Select camera for which to set up tamper-proof detection.
3. Check the **Enable Tamper-Proof** box.  
**Note:** Under **Area Settings**, the full screen is set for tamper-proof detection. This cannot be changed.
4. Select the **Arming Schedule** tab and click **Edit** to modify the arming schedule for video loss detection. The configuration is the same as that for the arming schedule for motion detection.
5. Select the **Linking Method** tab. Then select the response method to notify you of the alarm.
6. Click **Save** to save the settings.

## Exception

The exception type can be HDD full, HDD error, network disconnected, IP address conflict, invalid login, video signal exception, and record/capture exception.

- **HDD Full:** If there is a SD card, an alarm will be triggered when it is full. You can configure this option for overwrite to either Off or On. This also applies if you are using NAS storage.
- **HDD Error:** Errors occurred while files were being written to the HDD, no HDD installed or HDD had failed to initialize.
- **Network Disconnected:** Disconnected network cable.

- **IP Address Conflicted:** Conflict with IP address setting.
- **Invalid Login:** Wrong user ID or password used.
- **Video Signal Exception:** Poor video quality.
- **Record/Capture Exception:** No space on the HDD to save recorded files.

#### To configure exception:

1. Click **Configuration > Remote Configuration > Exception**. The Exception window appears.

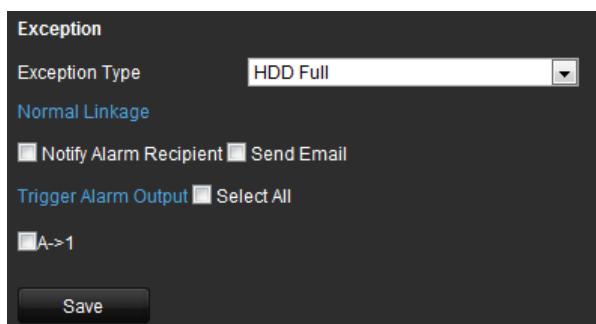

2. Select a notification type.

Under **Normal Linkage**, check one or more of the desired the response methods:

- **Audible warning:** Trigger an audible beep when an alarm is detected.  
**Note:** TVE-110/410 do not support audible warning.
- **Notify Alarm Recipient:** Send a notification or alarm signal to remote alarm host when an event occurs. The alarm host refers to the computer installed with remote client software
- **Send Email:** Send an email with alarm information to a user or users when an event occurs.

3. Check one or more response options: Audible warning, notify alarm recipient, send email, and trigger alarm output.
4. Click **Save** to save the settings.

## Privacy masking

You can define an area on screen to remain hidden from view. For example, you can choose to block the view of a camera when overlooking residential premises. This hidden area is referred to as privacy masking. Privacy masking cannot be viewed in live view or recorded mode, and appears as a blank area on the video image.

#### To configure a privacy mask:

1. Click **Configuration > Remote Configuration > Camera Settings > Privacy Mask**. The Privacy Mask window appears.
2. Select camera for which to set up privacy masking.

3. Check the **Enable Privacy Mask** box.

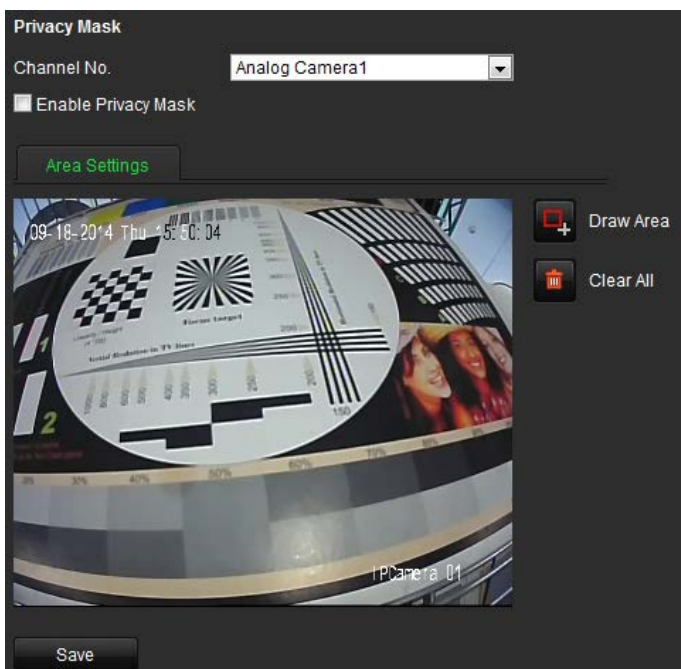

4. Click the **Draw Area** button to start drawing an area.
5. Using the mouse, click and drag a privacy-mask box in the camera view screen over the desired area. You can set up to four areas for privacy masking.
6. Click the **Stop Drawing** button to stop drawing.  
**Note:** Click the **Clear All** button to clear all mask areas.
7. Click **Save** to save the settings.

## RS-485 settings

The RS-485 serial port is used to control the PTZ of the camera. The PTZ parameters need to be configured before you control the PTZ unit. The PTZ protocols available are Interlogix-485, Kalatel, Pelco-D, Pelco-P, etc.

### To configure RS-485:

1. Click **Configuration > Remote Configuration > Serial Port Settings > RS-485**. The RS-485 window appears.

RS-485 Settings

Channel No. Analog Camera1

Baud Rate 9600

Data Bit 8

Stop Bit 1

Parity None

Flow Ctrl None

PTZ Protocol Interlogix-485

PTZ Address 0

Copy to Camera

Select All

A1

Save

2. Enter the RS-485 parameters. The default parameters are:

Baud rate: 9600

Data bit: 8

Stop bit: 1

Parity: None

Flow control: None

PTZ protocol: Interlogix-485

PTZ Address: 0

**Note:** It is important to ensure that the settings correspond with those used in the PTZ camera.

3. Click **Save** to save the settings.

## Scheduling record settings

Ensure that the NetHDD has been installed and initialized before configuring the recording settings.

### Description of the record schedule window

Defining a recording schedule lets you specify when the encoder records video and under what circumstances. Each camera can be configured to have its own recording schedule.

Figure 8: Description of the Record Schedule window

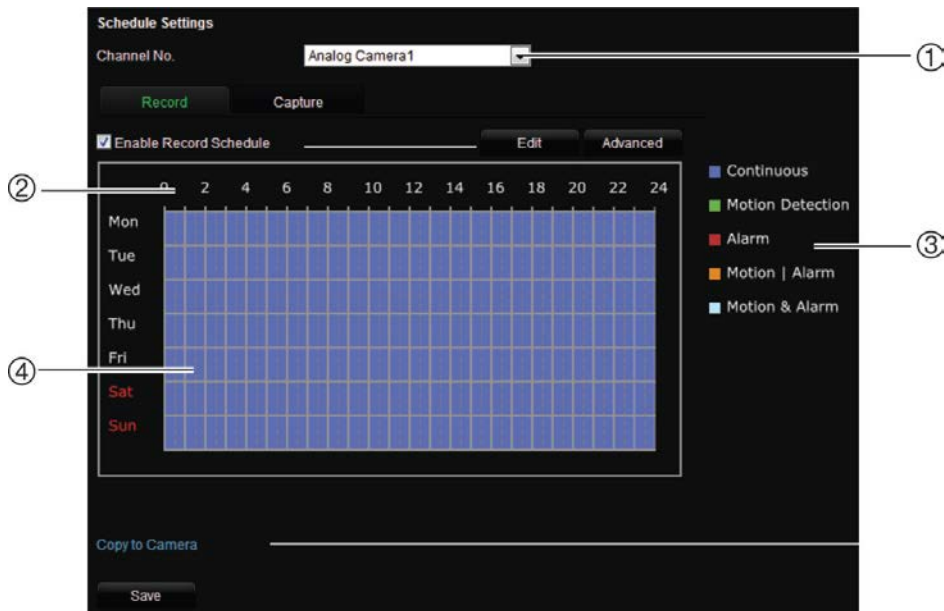

1. **Schedule time:** Represents the 24-hour cycle during which a schedule is selected.
2. **Channel No.:** Select a camera for the recording schedule.
3. **Recording type:** There are five recording types to select for the schedule, which are color-coded:
  - Normal (Blue): Records continuously.
  - Motion (Green): Records only motion events.
  - Alarm (Red): Records only alarm events.
  - Motion | Alarm (Orange): Records motion or alarm events.
  - Motion & Alarm (Pale blue): Records motion and alarm events.
4. **Timeline:** There is a 24-hour time line for each day. Each square in the timeline represents an hour in the 24-hour period. Up to eight recording periods can be scheduled during the 24-hour period.

**To configure a scheduled recording:**

1. Click **Configuration > Remote Configuration > Camera Settings > Schedule Settings**. The Record Schedule settings window appears.
2. Select the camera you want to configure.
3. Check the **Enable Record Schedule** box. If left unchecked, the encoder will not record.
4. Click **Edit** to configure the recording settings.



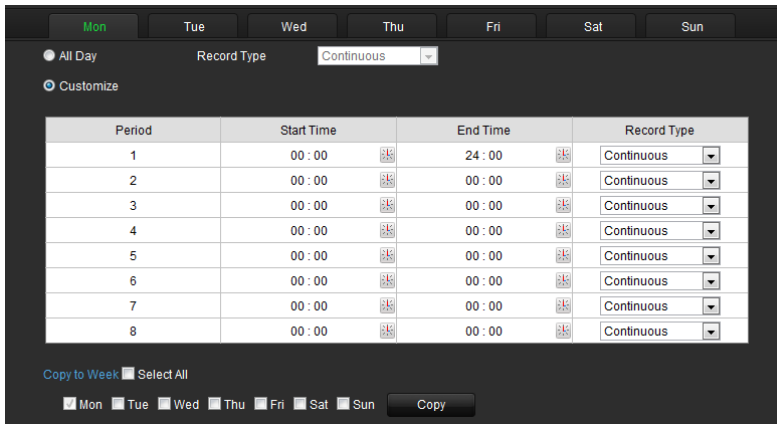

5. Configure the recording schedule. Check one of the following options:

**All day recording:** Check **All Day**.

**Customized recording:** Check **Customize**. Check the day of the week required and set the start and end time for recording. You can schedule up to eight time periods in a day. The segments cannot overlap.

6. Select a recording type.

This setting instructs the encoder to begin recording when an alarm is triggered. The recording types available are: Normal, Motion, Alarm, Motion or Alarm, Motion and Alarm.

**Note:** If Motion, Alarm, Motion or Alarm, Motion and Alarm types are selected, you must also configure the alarm linking method to be used. See “Motion detection” on page 34 and “Alarm settings” on page 36.

7. Copy the schedule to other days of the week.

Check **Select All** to copy the schedule to all days of the week. To copy these settings to another day, check the days required and click **Copy**.

**Note:** To configure different schedules for other days, click the tab for the desired day and set the schedule.

8. Click **OK** to save the settings. Return to the Record Schedule window.

9. Schedule pre and post recording times.

Click the **Advanced** button and select the desired times.

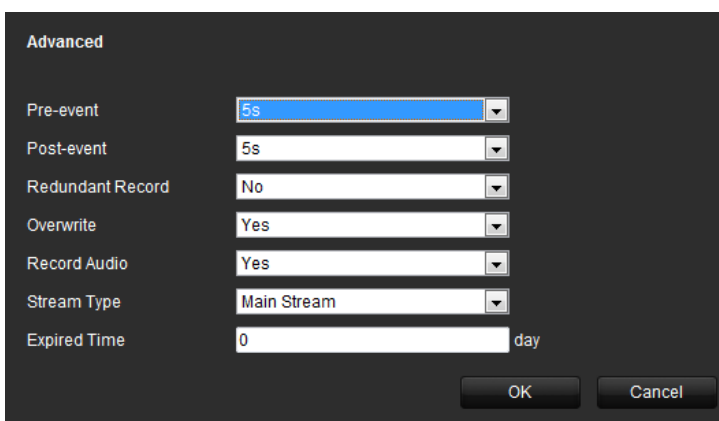

**Pre-event:** This is the time the camera starts recording before the scheduled time or event. The times available are: No pre-record, 5 s, 10 s, 15 s, 20 s, 25 s, 30 s or Unlimited.

**Post-event:** This is the time the camera continues to record after the scheduled time or event. The times available are: 5 s, 10 s, 30 s, 1 min, 2 min, 5 min or 10 min.

**Redundant Record:** When enabled, the recorded files are saved on the redundant HDD. You can enable or disable the redundant record by setting it to Yes or No.

Notes:

- The redundant record is used when you want to save the record files in the redundant HDD. You must configure the redundant HDD in the HDD settings menu.
- The Redundant Record option is only available when the selected HDD mode is Group.

**Overwrite:** Select to overwrite earlier recorded files or not when the HDD is full. If the Overwrite mode is enabled, the earlier recorded files will be overwritten when the HDD is full; otherwise, the recording will stop and trigger alarm when the HDD is full.

**Record Audio:** Enable or disable the audio record.

**Stream Type:** Select the Main Stream or Sub Stream for analog camera recording.

**Expired Time:** The expired time is the longest time that a recorded file is to be kept on the HDD. When the deadline is reached, the file will be deleted. If the expired time is set to 0, then the file will not be deleted. The actual time for the file to be saved should be determined by the capacity of the HDD.

10. Click **OK**. Return to the Record Schedule window.

11. Click **Save** to save the settings.

#### **To make redundant recordings:**

Use this option to back-up recordings as a safeguard against losing all the files in case of disk failure.

**Note:** You must have one NetHDD property identified as redundant to do redundant recording.

1. Configure the recording schedule of a camera.
2. Click **Advanced** in the Record Schedule window.
3. Under **Redundant Record** select the **Yes**.
4. Click **OK**. Return to the Record Schedule window.
5. Click **Save** to save the settings.

### To auto delete recordings:

1. Click **Configuration > Remote Configuration > Camera Settings > Record Schedule**. The Record Schedule window appears.
2. Configure the recording schedule of a camera.
3. Click **Advanced** in the Record Schedule window.  
Under **Expired Time** select the number of days after which recorded video from the specified camera is permanently deleted from the HDD.
4. Click **OK**. Return to the Record Schedule window.
5. Click **Save** to save the settings.

### To overwrite recordings:

Select to overwrite the earlier recorded files or not when the HDD is full. If the Overwrite mode is enabled, the earlier recorded files will be overwritten when the HDD is full; otherwise, the recording will stop and trigger alarm when the HDD is full.

1. Click **Configuration > Remote Configuration > Camera Settings > Record Schedule**. The Record Schedule window appears.
2. Configure the recording schedule of a camera.
3. Click **Advanced** in the Record Schedule window.  
Under **Overwrite** select Yes, the earlier recorded files will be overwritten when the HDD is full.
4. Click **OK**. Return to the Record Schedule window.
5. Click **Save** to save the settings.

### To record audio:

1. Click **Configuration > Remote Configuration > Camera Settings > Record Schedule**. The Record Schedule window appears.
2. Configure the recording schedule of a camera.
3. Click **Advanced** in the Record Schedule window.  
Under **Record Audio** select Yes to enable the audio record.
4. Click **OK**. Return to the Record Schedule window.
5. Click **Save** to save the settings.

### To configure record stream type:

1. Click **Configuration > Remote Configuration > Camera Settings > Record Schedule**. The Record Schedule window appears.
2. Configure the recording schedule of a camera.
3. Click **Advanced** in the Record Schedule window.  
Under **Stream Type** select **Main Stream** or **Sub Stream** for analog camera recording.

4. Click **OK**. Return to the Record Schedule window.
5. Click **Save** to save the settings.

## Holiday settings

You can schedule recordings for specific holidays in the year such as the first of January, or the second Wednesday of every month, for example. You can schedule up to 32 holiday periods.

### To configure holiday settings

1. Click **Configuration > Remote Configuration > Camera Settings > Holiday Settings**. The holiday setting window appears.

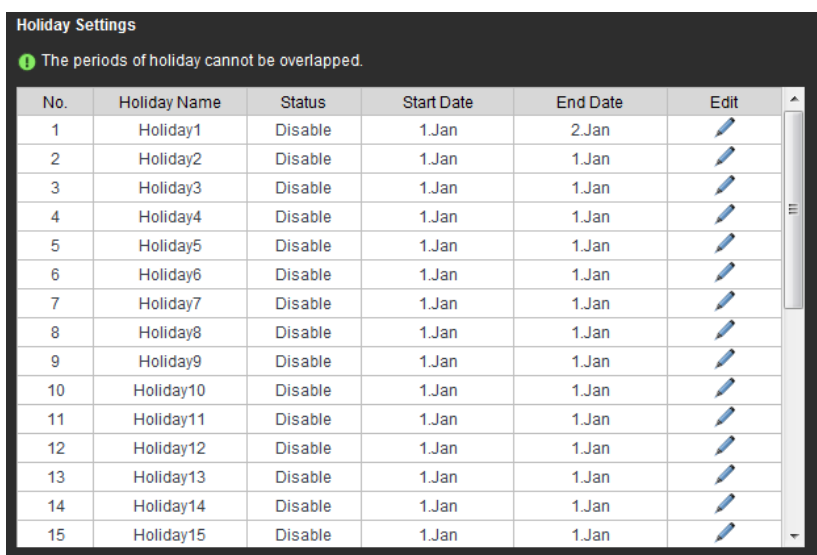

The screenshot shows the 'Holiday Settings' window with a message: 'The periods of holiday cannot be overlapped.' Below the message is a table with 15 rows and 6 columns: No., Holiday Name, Status, Start Date, End Date, and Edit. Each row represents a holiday configuration, with 'Status' set to 'Disable' and 'Edit' represented by a pencil icon.

No.	Holiday Name	Status	Start Date	End Date	Edit
1	Holiday1	Disable	1.Jan	2.Jan	
2	Holiday2	Disable	1.Jan	1.Jan	
3	Holiday3	Disable	1.Jan	1.Jan	
4	Holiday4	Disable	1.Jan	1.Jan	
5	Holiday5	Disable	1.Jan	1.Jan	
6	Holiday6	Disable	1.Jan	1.Jan	
7	Holiday7	Disable	1.Jan	1.Jan	
8	Holiday8	Disable	1.Jan	1.Jan	
9	Holiday9	Disable	1.Jan	1.Jan	
10	Holiday10	Disable	1.Jan	1.Jan	
11	Holiday11	Disable	1.Jan	1.Jan	
12	Holiday12	Disable	1.Jan	1.Jan	
13	Holiday13	Disable	1.Jan	1.Jan	
14	Holiday14	Disable	1.Jan	1.Jan	
15	Holiday15	Disable	1.Jan	1.Jan	

2. Select an item from the list and click to edit the holiday.

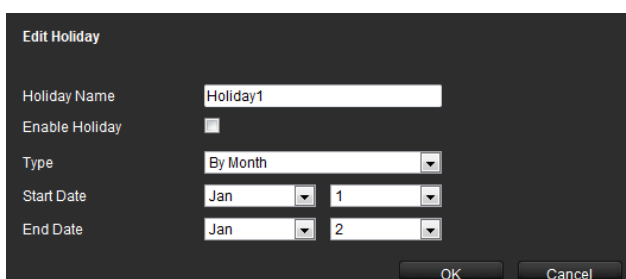

The screenshot shows the 'Edit Holiday' dialog box with the following fields:

- Holiday Name: Holiday1
- Enable Holiday:
- Type: By Month
- Start Date: Jan 1
- End Date: Jan 2

Buttons: OK, Cancel

Enter the holiday name.

Check the **Enable Holiday** checkbox.

Select the holiday type from the dropdown list. You can select by month, by week, or by date.

Set the start and end date.

Click **OK** to save the settings and return to the Holiday Settings window.

3. You can check the finished holiday settings on the list.
4. Repeat the same steps to edit other holidays. Up to 32 holidays can be configured.

**Note:** The Holiday option is available in the Schedule dropdown list when you have enabled holiday schedule in the Edit Holiday settings window.

## Managing user accounts

By default the encoder comes with three user accounts: an Administrator account, an Operator account, and a Viewer account. These accounts provide multiple levels of access and functionality. See Table 3 below for a description of the different user accounts.

**Table 2: User accounts**

User	Description
<b>Administrator</b>	<p>The administrator account includes full access to all settings. The Administrator has the authority to add, delete or configure parameters for many of the system functions.</p> <p>There can only be one administrator.</p> <p>The user name is admin. The name cannot be modified.</p> <p>The default password is 1234.</p>
<b>Operator</b>	<p>The default operator account includes access to remote view logs/status, bi-directional audio, live view, PTZ control and playback (inaccessible features are not visible). The administrator can change the access privileges under Basic Permission and Camera Operation.</p> <p>There is no default user name and password. The administrator must create the user name and password.</p>
<b>Viewer</b>	<p>The default user account includes access to remote view logs/status and playback (inaccessible features are not visible). The administrator can change the access privileges under Basic Permission and Camera Operation.</p> <p>There is no default user name and password. The administrator must create the user name and password.</p>

**Note:** Default passwords should be changed for security reasons.

### To add a new user:

1. Click **Configuration > Remote Configuration > User Management**. The User Information window appears.

**Note:** Only a system administrator can create a user. You can add up to 31 new users.

2. Click **Add**. The Add User window appears.

3. Enter the user name and password. Both the user name and password can have up to 16 alphanumeric characters.
4. Select the user type: Operator or Viewer.
5. Define the user's permissions under **Basic Permission** and **Camera Configuration**.

**Basic configuration:**

- Remote: Parameter Settings
- Remote: Log search / Interrogate Working Status
- Remote: Upgrade / Format
- Remote: Bidirectional Audio
- Remote: Shutdown / Reboot
- Remote: Notify Alarm Recipient / Trigger Alarm Output
- Remote: Serial Port Control

**Camera configuration:**

- Remote: Live View (Default = All cameras enabled)
- Remote: Manual Record (Default = All cameras enabled)
- Remote: PTZ Control (Default = All cameras enabled)
- Remote: Playback (Default = All cameras enabled)

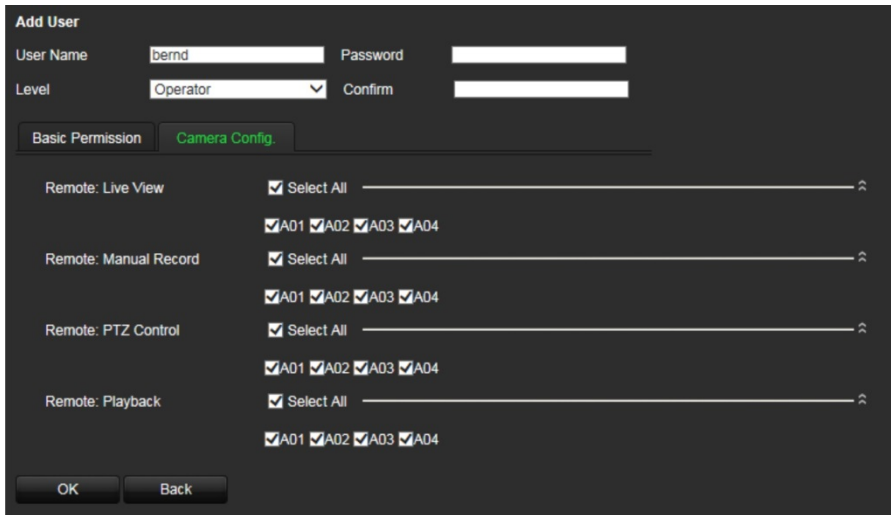

6. Click **OK**.

**To modify a user:**

1. Click **Configuration > Remote Configuration > User Management**. The User Information window appears.
2. Click **Modify**. The Modify User window appears.

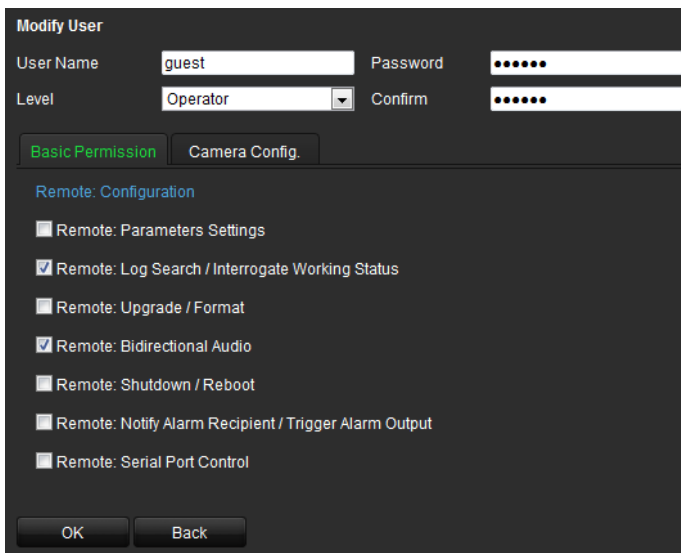

3. Modify the user information such as the user name and password, user type, and user's permissions under **Basic Permission** and **Camera Config**.

4. Click **OK**.

**To delete a user:**





1. Click **Configuration > Remote Configuration > User Management**. The User Information window appears.
2. Select a user account from the list to be deleted. Click **Delete**.
3. Click **OK** in the pop-up window to confirm deletion. The user is immediately deleted.
4. Click **OK**.

# Playback

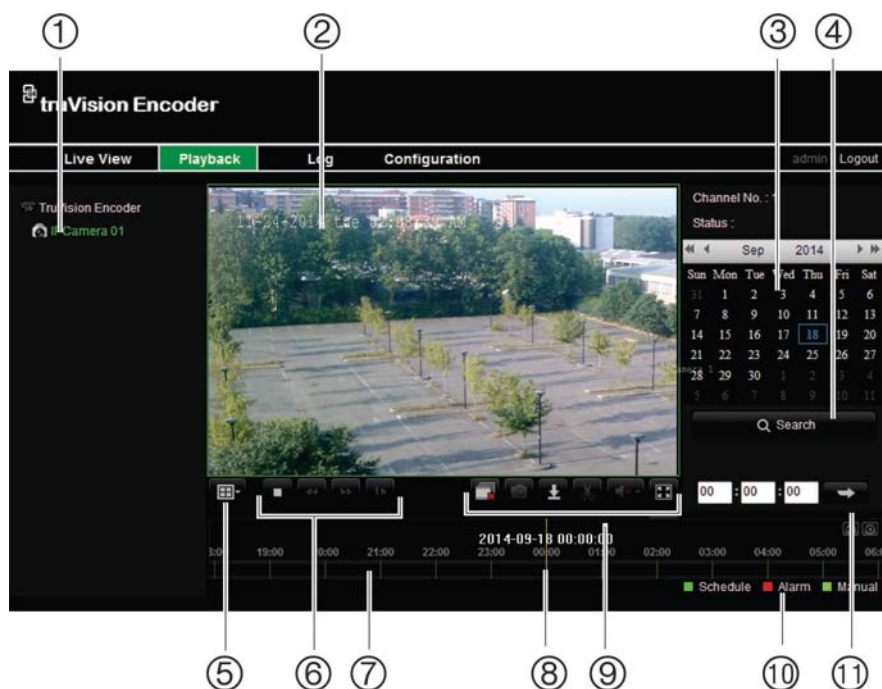





You can easily search and play back recorded videos by camera, date and time. A search will usually produce a list of files, which may extend to several pages. Only one file can be played back at a time.

Figure 9: Playback window



Item	Name	Description
1.	Camera panel	Select the cameras for playback.
2.	Playback viewer	The playback video has a time/date stamp on it for evidentiary purposes.
3.	Calendar panel	Select a date to playback recordings.
4.	Search panel	Results of search displayed here.
5.	Display format	 Define how you want video to be displayed in the viewer; single window, 2X2, 3X3 or 4X4. When in multiview mode, double-click on a video tile to get full-screen mode. Double-click again to return to multiview mode.
6.	Playback control toolbar	 Start/stop playback recording. <hr/>  Decrease playback speed: Options available are: single frame, 1/8 speed, 1/4 speed, 1/2 speed, normal, X2 speed, X4 speed, X8 speed, maximum speed. <hr/>  Increase playback speed. Options available are: single frame, 1/4 speed, 1/2 speed, normal, X2 speed, X4 speed, maximum speed.



Item	Name	Description
		 Play back frame-by-frame. This allows you to carefully examine an event frame-by-frame as it happens
7.	Timeline	Allows you to jump forwards or backwards in time. The timeline moves left (oldest video) to right (newest video). Click a location on it for where you want playback to start. It also shows the type of recording by color coding.
8.	Time bar	Time of actual playback. Drag the bar to an exact spot where you want playback to start.
9.	Video and audio control	 Stop playback for all cameras.  Capture a snapshot of a video image. The image is saved on the computer.  Download video files found in the search.  Start/stop video clip during playback. Sections of a recording can be saved to an external storage device.  Turn audio on/off.  Switch to full screen mode.
10.	Recording type	Description of the color coding of recording types shown in the timeline. Green indicates continuous recording. Red indicates alarm/event recording. Light green indicates manual recording.
11.	Time selection box	Enter an exact time to start playback.

### To play back a recording:

1. Click the **Playback** button on the menu toolbar. The Playback window appears.
2. Select a camera and date for play back. Click **Search**.
3. Click **Play** to start playback.
4. Use the playback control toolbar to manually control playback.
5. To select an exact time to start playback, drag the time bar to where you want playback to start . You can also enter the exact time into the time selection box and click .

# Encoder management

## Searching system logs

Many events, such as operation, alarms and notifications, are logged into the encoder's system logs. They can be viewed and exported at any time.

**Note:** Connect a NetHDD to the encoder before starting the log search. The network disc must be initialized.

### To search system logs:

1. Click the **Log** button on the menu toolbar. The Log window appears.

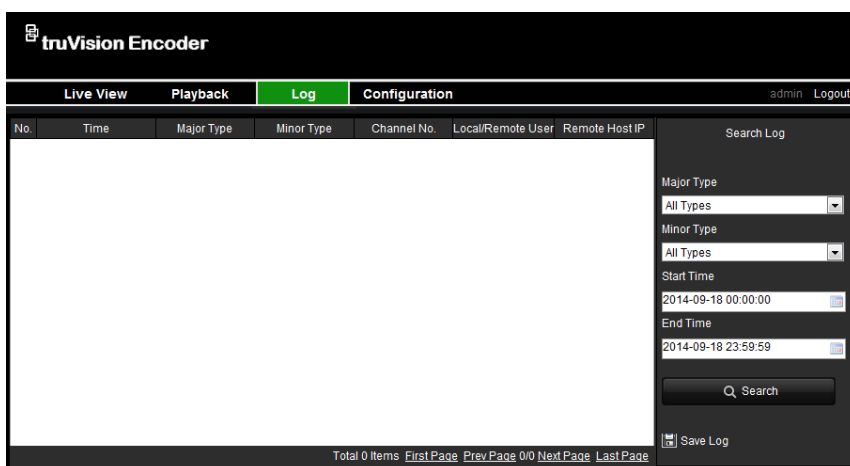

2. Select the search start and end times.
3. Under **Major Type** and **Minor Type**, select an option from the drop-down list. The minor type list of options available depends on the option selected under major type.
4. Click the **Search** button. A list of results appears in the panel below.
5. Click **Save Log** to save a log file to a local directory.

## Restoring default settings

### To restore the default factory settings:

1. Click **Configuration > Maintenance**.
2. Click **Restore** or **Default**.

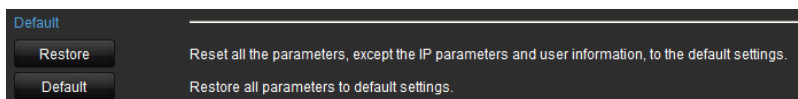

**Restore:** All parameters except those for IP address, subnet mask, gateway, and server port are restored to factory default settings.

**Default:** All parameters are restored to factory default settings.

3. Click **OK** to confirm you want to restore default settings.

## Viewing device information

You can change the encoder name and number as well as view information about the device such as model and serial numbers, firmware version, encoder version, number of HDDs, and the number of alarm inputs and outputs.

### To view device information:

1. Click **Configuration > Device Parameters > Device Information**. The Basic Information window appears

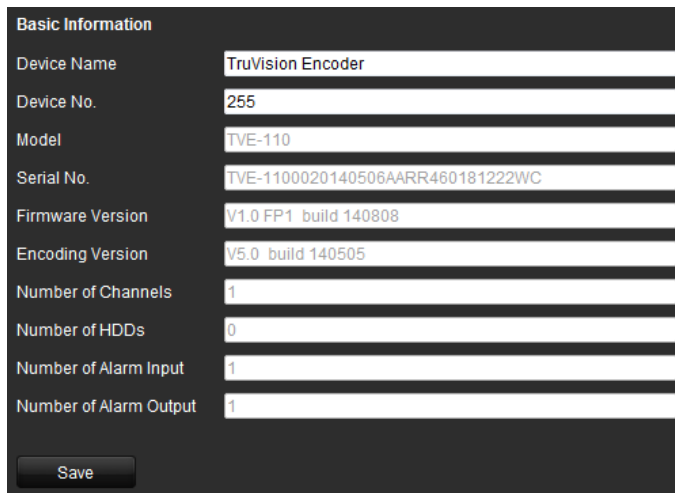

The screenshot shows a 'Basic Information' configuration window with the following fields and values:

Field	Value
Device Name	TruVision Encoder
Device No.	255
Model	TVE-110
Serial No.	TVE-1100020140506AARR460181222WC
Firmware Version	V1.0 FP1 build 140808
Encoding Version	V5.0 build 140505
Number of Channels	1
Number of HDDs	0
Number of Alarm Input	1
Number of Alarm Output	1

A 'Save' button is located at the bottom left of the window.

2. Change the device name or number, if required.
3. Click **Save** to save the settings.

## Restarting the device

### To restart the encoder:

1. Click **Configuration > Maintenance**. The Maintenance window appears.

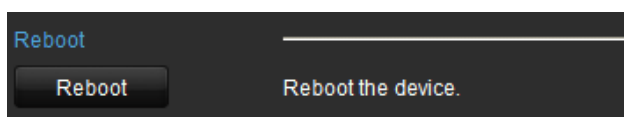

2. Click **Reboot**.
3. Enter your user name and password and click **OK**. The encoder restarts.

## Importing/exporting parameters

The configuration files of the device can be exported to a local back-up device.

The configuration files of one device can be imported to multiple device devices if they are to be configured with the same parameters.

1. Click **Configuration > Maintenance**. The maintenance window appears.



2. To export the files, under “Export Config. File”, click **Export**. The files are downloaded to the back-up device.
3. To import files, under “Import Config. File”, click **Browse** to locate the file to be imported from a local back-up device. Click **Import** to start importing.

## Upgrading the system

The encoder firmware can be upgraded remotely.

### To upgrade the encoder:

1. Click **Configuration > Maintenance**. The Maintenance window appears.

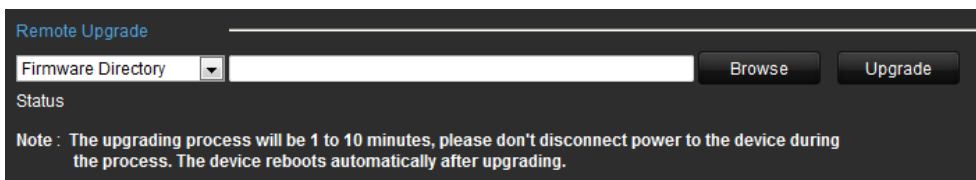

2. Under “Remote Upgrade”, click **Browse** to locate the upgrade file from a local back-up device. Click **Upgrade** to start importing.

# Specifications

Model	TVE-110	
Video/Audio input	Video compression	H.264/MPEG4/MJPEG
	Analog video input	1-ch, BNC connector (1.0 Vp-p, 75 Ω); PAL / NTSC adaptive
	Audio compression	G.711
	Audio input	1-ch, 3.5mm interface
	Bi-directional audio input	1-ch, 3.5mm interface (Using AUDIO IN)
	Audio output	1-ch, 3.5mm interface (Linear, 600 Ω)
Video/Audio output	Recording resolution	960H / 4CIF / 2CIF / CIF / QCIF
	Frame rate	Main stream: 960H / 4CIF / 2CIF / CIF @ 25 fps (P) / 30 fps (N) Substream: 960H @ 2 fps / 4CIF @ 4 fps / 2 CIF @ 8fps / CIF @ 12 fps / QCIF @ 25 fps(P) 30fps(N)
	Video bit rate	32 kbps to 8192 kbps
	Stream type	Video/ Video & Audio
	Audio bit rate	64 kbps
	Dual stream	Support
	External interface	Network interface
Serial port		1 RS-485 interface, half-duplex
Alarm in		1
Alarm out		1
Others	Protocol	Support CGI, PSIA and ONVIF
	Consumption	Max. 6W
	Operating temperature	-10 to +55 C° (14 to 131 °F)
	Operating humidity	10 to 90%
	Dimensions	80 x 39 x 90 mm
	Weight	270 g (0.59 lb.)

Model	TVE-410	
Video/Audio input	Video compression	H.264/MPEG4/MJPEG
	Analog video input	4-ch, BNC connector (1.0 Vp-p, 75 Ω);
	Audio compression	G.711
	Audio input	4-ch,
	Bi-directional audio input	1-ch, 3.5mm interface
	Audio output	1-ch, 3.5mm interface (Linear, 600Ω)

Model	TVE-410	
Video/Audio output	Recording resolution	960H / 4CIF / 2CIF / CIF / QCIF
	Frame rate	Main stream: 960H / 4CIF / 2CIF / CIF @ 25 fps (P) / 30 fps (N) Substream: 960H @ 2 fps / 4CIF @4 fps / 2 CIF @ 8fps / CIF @12 fps / QCIF @ 25 fps(P) 30fps(N)
	Video bit rate	32 kbps to 8192 kbps
	Stream type	Video/ Video & Audio
	Audio bit rate	64 kbps
	Dual stream	Support
	External interface	Network interface
Serial port		1 RS-485 interface, half-duplex
Alarm in		4
Alarm out		2
Others	Protocol	Support CGI, PSIA and ONVIF
	Consumption	Max. 8W
	Operating temperature	-10 to +55 C° (14 to 131 °F)
	Operating humidity	10 to 90%
	Dimensions	114 x 48 x 128 mm
	Weight	557 g (1.23 lb.)

Model	TVE-810	
Video/Audio input	Video compression	H.264/MPEG4/MJPEG
	Analog video input	8-ch, BNC connector (1.0 Vp-p, 75 Ω)
	Audio compression	G.711
	Audio input	8-ch,
	Bi-directional audio input	1-ch, 3.5mm interface (2.0 Vp-p, 1 kΩ)
	Audio output	1-ch, 3.5mm interface (Linear, 600Ω)
Video/Audio output	Recording resolution	960H/ 4CIF / 2CIF / CIF / QCIF
	Frame rate	Main stream: 960H / 4CIF / 2CIF / CIF @ 25 fps (P) / 30 fps (N) Substream: 960H @ 2 fps / 4CIF @4 fps / 2 CIF @ 8fps / CIF @12 fps / QCIF @ 25 fps(P) 30fps(N)
	Video bit rate	32 kbps to 8192 kbps
	Stream type	Video/ Video & Audio
	Audio bit rate	64 kbps
	Dual stream	Support
	External	Network port

Model	TVE-810	
interface	Serial port	1 RS-485 port, half-duplex
	Alarm in	8
	Alarm out	4
Others	Protocol	Support CGI, PSIA and ONVIF
	Consumption	Max. 10W
	Operating temperature	-10 to +55 C° (14 to 131 °F)
	Operating humidity	10 to 90%
	Dimensions	315 x 45 x 200 mm
	Weight	1396 g (3.08 lb.)

Model	TVE-1610	
Video/Audio input	Video compression	H.264/MPEG4/MJPEG
	Analog video input	16-ch, BNC connector (1.0 Vp-p, 75 Ω);
	Audio compression	G.711
	Audio input	16-ch,
	Bi-directional audio input	1-ch, 3.5 mm interface (2.0 Vp-p, 1 kΩ)
	Audio output	1-ch, 3.5 mm interface (Linear, 600 Ω)
Video/Audio output	Recording resolution	960H / 4CIF / 2CIF / CIF
	Frame rate	Main stream: 960H / 4CIF / 2CIF / CIF @ 25 fps (P) / 30 fps (N) Substream: 960H @ 2 fps / 4CIF @ 4 fps / 2 CIF @ 8fps / CIF @ 12 fps / QCIF @ 25 fps(P) 30fps(N)
	Video bit rate	32 kbps to 8192 kbps
	Stream type	Video/ Video & Audio
	Audio bit rate	64 kbps
	Dual stream	Support
	External interface	Network port
Serial port		1 RS-485 port, half-duplex
Alarm in		16
Alarm out		4
Others	Protocol	Support CGI, PSIA and ONVIF
	Consumption	Max. 22W
	Operating temperature	-10 to +55 C° (14 to 131 °F)
	Operating humidity	10 to 90%
	Dimensions	440 x 45 x 274 mm
	Weight	2486 g (5.48 lb.)

